

INSTRUCTION MANUAL

N/NT/NL/NLT type

Closed Center Power Chuck



DANGER

- This instruction manual is for production engineers and maintenance personnel in charge of operation of this product. When a beginner uses this product, receive instructions from experienced personnel, the distributor or our company.
- Before installing, operating or maintaining this equipment, carefully read this manual and the safety labels attached to the equipment. Failure to follow these instructions and safety precautions could result in serious injury, death, or property damage.
- Store this manual near equipment for future reference.
- If any questions related to safety arise about this manual, please confirm them with the distributor or our company.

Kitagawa Corporation

77-1, Motomachi, Fuchu-shi, Hiroshima, 726-8610, Japan

Tel. +81-847-40-0561

Fax. +81-847-45-8911

Preface

This manual provides detailed information about how to safely and correctly use the power chuck (N / NT / NL / NLT type) for a lathe.

Before starting to use this power chuck, read this manual carefully and always follow the instructions and warnings in "**Important Safety Precautions**" and "**Precautions for Use**" at beginning of the manual. Failure to follow these precautions could result in a serious accident.

Terms and Symbols Used for Safety Messages

In this manual, precautions for handling that are considered especially important are classified and displayed as shown below depending on the damage of risk including the seriousness of the harm that could result. Please sufficiently understand the meanings of these terms and follow the instructions for safe operation.

Safety Alert Symbol

The triangle is the safety alert symbol used to alert you to potential safety hazards that could result in injury or death.



Indicates a hazardous situation which, if you not avoided, will result in death or serious injury.



Indicates a hazardous situation which, if you not avoided, could result in death or serious injury.



Indicates a hazardous situation which, if you not avoided, could result in minor or moderate injury.



Indicates instructions which, if not avoided, could result in damage to the equipment or a shortened work life.

Liability and How to Use this Manual

This product is suitable for gripping a workpiece on the lathes or rotary tables. This product is equipped with the jaws to clamp the workpiece and they operate by means of a rotary cylinder. For any other applications, please contact us.

Our company will not assume responsibility for injury, death, damage, or loss resulting from not following the instructions in this manual.

There are countless things that cannot or should not be done, and it is impossible to cover all of them in this manual.

Therefore, do not perform any actions unless they are specifically allowed in this manual. If any questions related to safety arise about operation, control, inspection and maintenance which are not specified in this manual, please confirm them with our company or distributor before performing them.

Guarantee and Limitation of Liability

The guarantee period of this product is 1 year after delivery.

Use the parts delivered by Kitagawa Corporation for all the parts including consumable parts. We will not assume responsibility for injury, death, damage, or loss caused by usage of parts not manufactured by Kitagawa Corporation. Additionally, if parts other than genuine parts manufactured by Kitagawa Corporation are used, this guarantee will be completely invalid.

The chuck and cylinder from Kitagawa Corporation should be used together. If you must use a part not made by Kitagawa, check with us or our distributor to be sure it is safe to do so. We will not be responsible for injury, death, damage or loss caused by use of a chuck or cylinder made by another company unless this use has been approved by Kitagawa or its distributor.

Table of Contents

1. Structural Drawing and Parts List	3
1-1. Type display	
1-2. Structural drawing	
1-3. Scope of product	
1-4. Parts list	
2.  Important Safety Precautions	6
3. Specifications	12
3-1. Specifications	
3-2. Relationship between gripping force and rotation speed	
3-3. Relationship between gripping part center height, static gripping force and input force / Relationship between top jaw mass moment and gripping force loss	
4. Forming Soft Jaw	26
4-1. Attachment of soft jaw	
4-2. Forming soft jaw with outside diameter gripping	
4-3. Forming soft jaw with inside diameter gripping	
4-4. Forming method when you use forming jig	
5. Usage	30
5-1. Precautions during gripping work with chuck	
5-2. Precautions during gripping work in irregular shape	
5-3. Precautions related to usage of jaw	
5-4. Precautions related to processing	
5-5. Attachment of locator and jig	
6. Maintenance and Inspection	33
6-1. Periodic Inspection	
6-2. Grease lubrication	
6-3. Disassembling	
7. Malfunction and Countermeasures	36
7-1. In the case of malfunction	
7-2. Where to contact in the case of malfunction	
 For Machine Tool Manufacturers (Chapter 8)	
8. Attachment	37
8-1. Outline drawing of attachment	
8-2. In the case that the back plate must be manufactured	
8-3. In the case of with back plate	
8-4. Attachment of chuck	
9. Other Information	44
9-1. About standards and orders	
9-2. Information about markings of product	
9-3. About disposal	

1 . Structural Drawing and Parts List

1-1 Type display

Type display as shown below

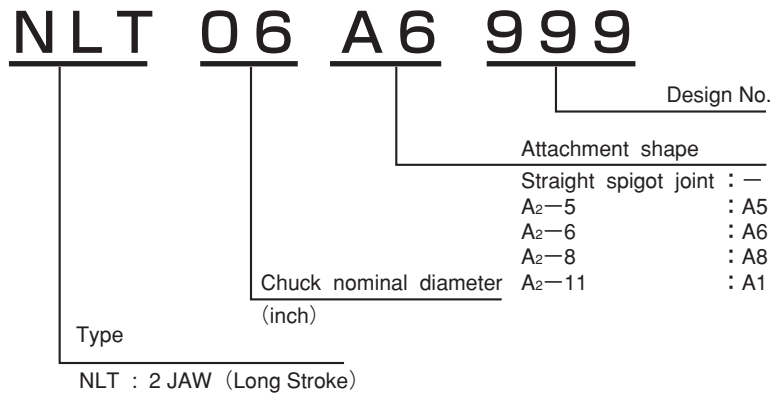
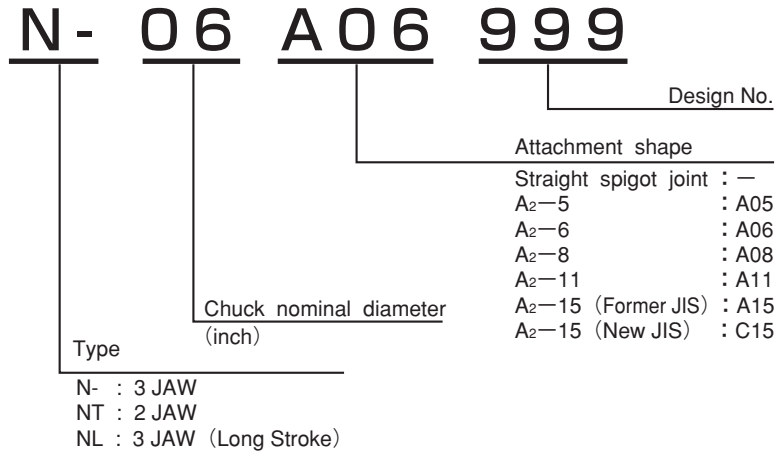
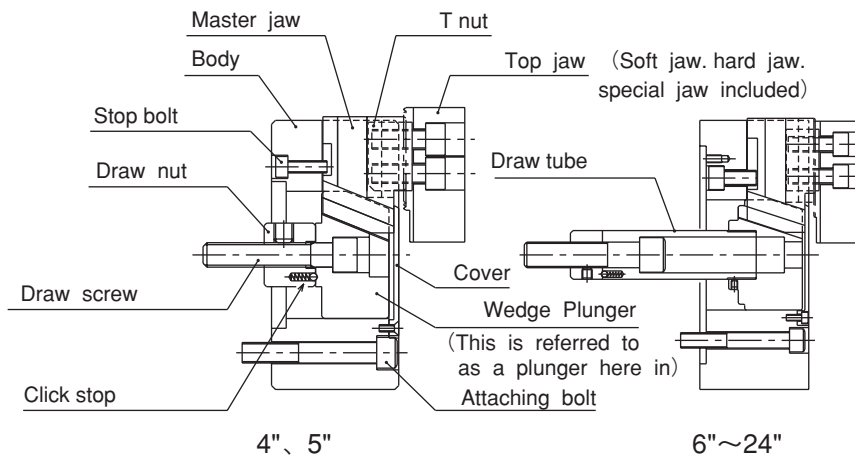

Fig.1

1-2 Structural drawing



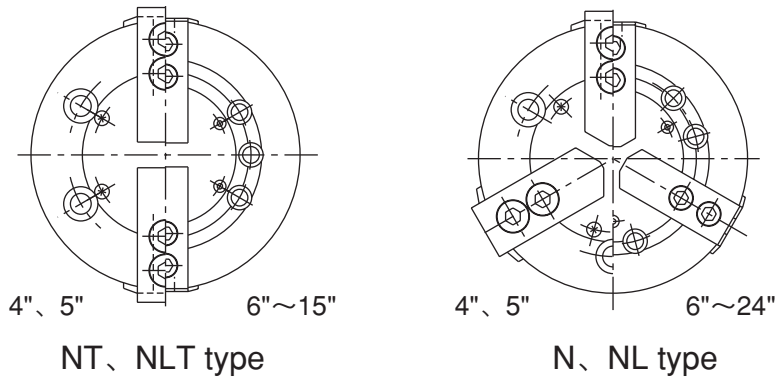

Fig.2

1-3 Scope of product

This instruction manual is for the chuck part.

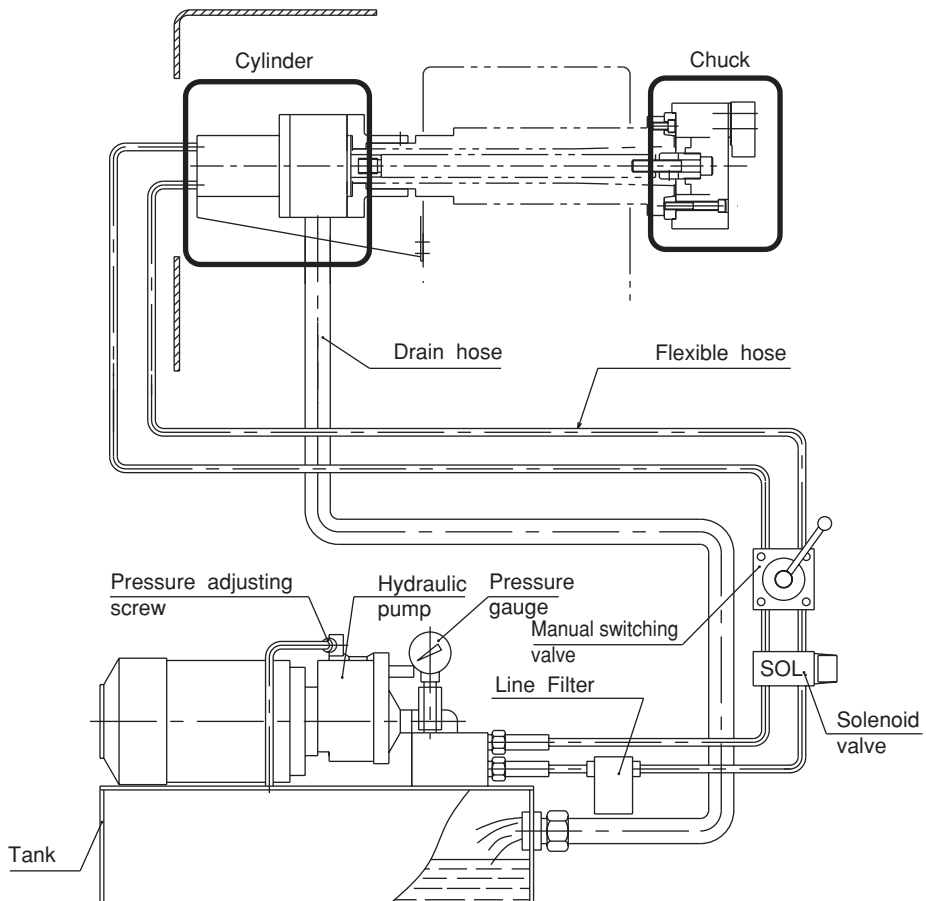

Fig.3

⚠ WARNING

- To prevent the work from flying, safe design, maintenance and erroneous action prevention of the hydraulic system to maintain the gripping force of the chuck is extremely important. Thoroughly read the “Important Safety Precautions” on and after page 6 in this manual.
- As for the cylinder, follow the instruction manual for the cylinder.

1-4 Parts list

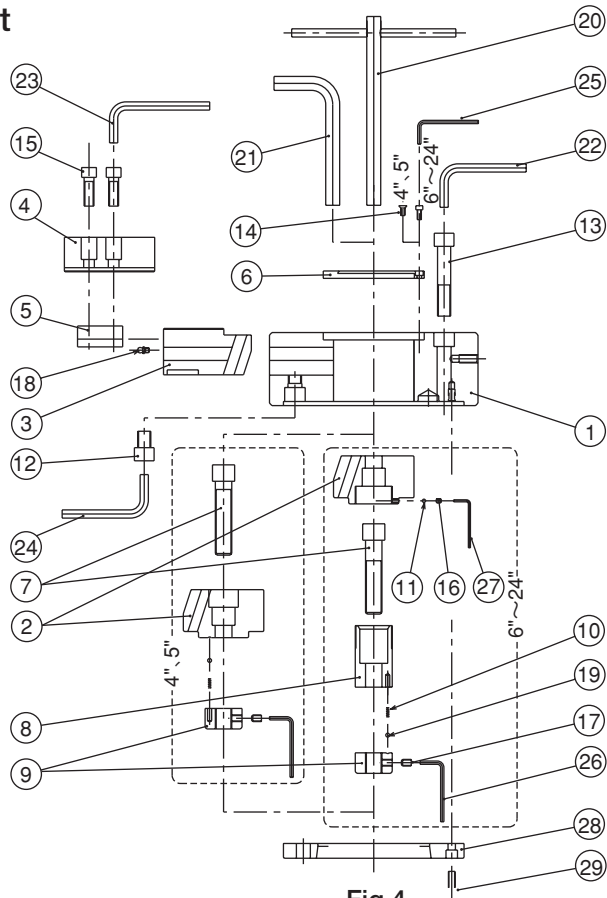

Fig.4

Table 1

No.	Part name	Quantity	No.	Part name	Quantity
1	Body	1	16	Set screw	1
2	Wedge plunger	1	17	Set screw	1
3	Master jaw	2or3	18	Grease nipple	2or3
4	Soft jaw	2or3	19	Steel ball	1
5	T nut	2or3 ^{*1}	20	Handle	1 ^{*5}
6	Cover	1	21	Hex key	1 ^{*6}
7	Draw screw	1	22	Hex key	1
8	Draw tube	1 ^{*2}	23	Hex key	1
9	Draw nut	1	24	Hex key	1
10	Spring	1	25	Hex key	1
11	Lead ball	1	26	Hex key	1
12	Stop bolt	2or3	27	Hex key	1
13	Chuck attaching bolt	6 ^{*3}			
14	Socket head cap screw	3or4 ^{*4}	28	Back plate	1 ^{*7}
	Machine screw		29	Socket head cap screw	3 ^{*7}
15	Jaw attaching bolt	4or6			

*1. N-15 or more: 6 pieces.

*2. Exclude 4" and 5"

*3. N-04, N-05, NL04 and NL05 : 3 pieces. NT04 and NT05 : 4 pices.

*4. 4" and 5" : Machine screw, 6" or more : Socket Head cap screw.

*5. 6" or more. (Exclude NL12)

*6. 4", 5" and NL12.

*7. Only supplied if there is a back plate.

2. Important Safety Precautions

Important safety precautions are summarized below. Please read this section before first starting to use this product.



DANGER

Failure to follow the safety precautions below will result in serious injury or death.



Turn off main power supply before attaching, inspecting or replacing chuck, and before adding oil.

For All Users

- The chuck may start rotation suddenly, and a part of the body or clothing may be caught.

Main power supply

OFF

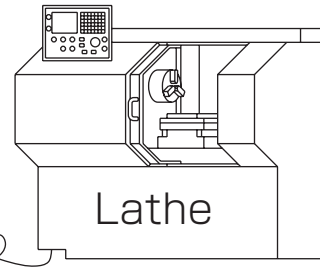
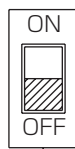

Close door before rotating spindle.

For All Users

- If the door is not closed, you may touch the rotating chuck or the work may fly out, which is very dangerous. (In general, the safety interlock function which allows rotation only when the door is the manual mode or the test mode)

Close

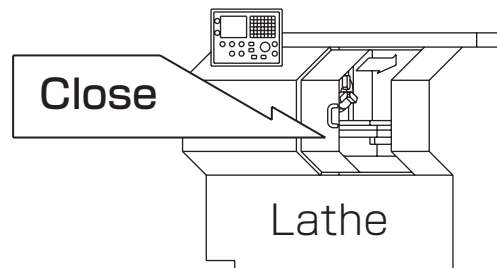

During spindle rotation, do not turn off hydraulic pump power supply and do not operate switching valve.

For All Users

- Cutting off hydraulic pressure causes a drop in the gripping force which could result in the work being released and flying out.
- Operating the manual switching valve or solenoid valve will lead to a drop of hydraulic pressure.

Manual switching valve

Jaw closed



Jaw open

NO



Solenoid valve

Work

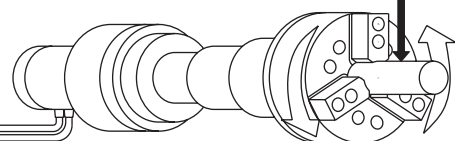



DANGER

Failure to follow the safety precautions below will result in serious injury or death.



Do not allow the rotation speed of the chuck to exceed the maximum allowable speed limit. (Refer to pages 16-25)

For All Users

- If the rotation speed of the chuck exceeds the rotation speed limit, this is very dangerous as the chuck and work will fly out.

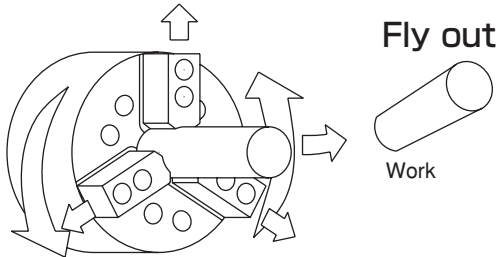

The input force of the chuck (piston thrust, pulling force of the draw bar) must not exceed the allowable maximum input force. (Refer to pages 16-25)

For All Users

- Input must match the specification of the chuck.
- Adjust the hydraulic pressure to the cylinder so that the input force, which determines the gripping force of the chuck, does not exceed.
- Excessive input force can lead to breakage of the chuck, which is very dangerous, as the chuck can be damaged and fly out.

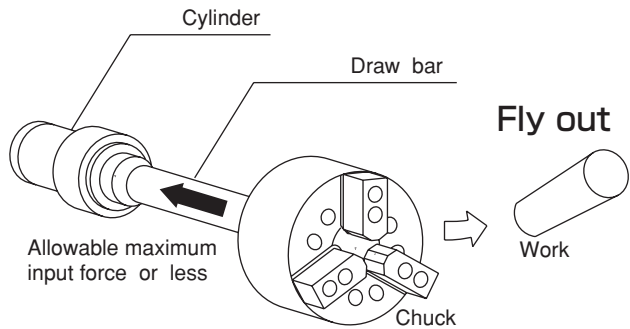

Keep the height of the jaw within the range specified in the gripping force limit table (Refer to page 20-24). If you must use a jaw taller than a standard soft jaw, use less than the input (piston thrust force, draw bar drawing force) specified in the gripping force limit table.

For All Users

- Do not use a jaw of a height out of the range of the gripping force limit table or a jaw with mass moment out of the range of the gripping force limit table. The chuck will break and the chuck and work will break and fly out.

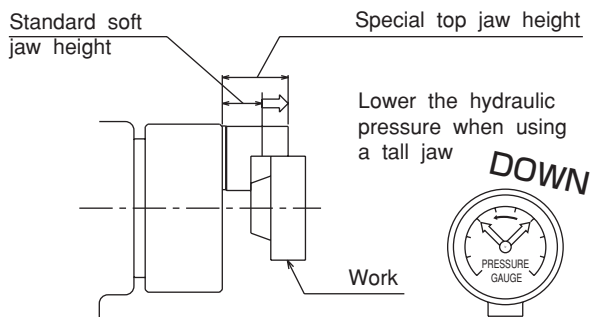



DANGER

Failure to follow the safety precautions below will result in serious injury or death.



When the protrusion of the work is long, support it with the steady rest or center.

For All Users

- If the protrusion is long, the tip of the work can turn and the work fly out.

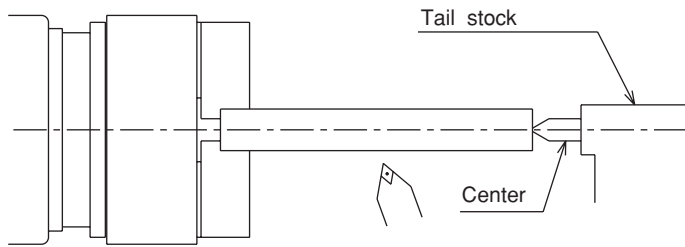

Determine the gripping force required for processing by the machine tool manufacturer or user, and check that the required gripping force is provided before processing. (Refer to pages 16-25 and cylinder manual)

For All Users

- Adjust the hydraulic pressure to the cylinder to obtain the required gripping force. If the gripping force is insufficient, this is dangerous as the work will fly out.

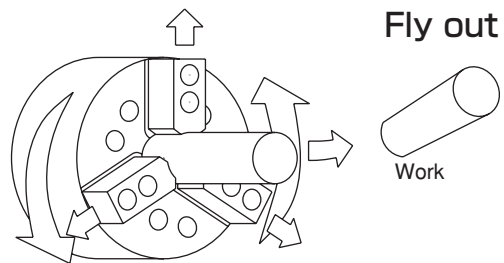

Use of a chuck and cylinder that cannot be used together safely may cause the cylinder to break at high pressure resulting in the chuck and work flying out.

For All Users

- Check that the chuck and the cylinder are in the “safe combination” when using at high pressure with our company or the distributor. Especially when the cylinder of our company and a high pressure chuck of other company are combined, confirmation is necessary.
- If one of the abnormal events shown below occurs during operation, immediately stop the machine and consult with our company or the distributor.
 - The work slips.
 - Loss of accuracy.
 - The work begins to chatter.
 - The machine's vibration significantly increases.
 - The gripping force does not rise even if hydraulic pressure is raised.

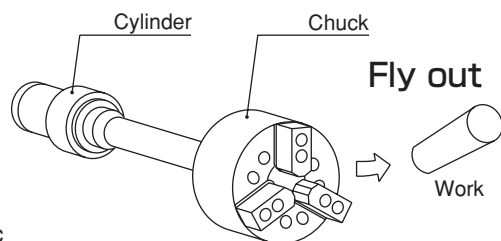



DANGER

Failure to follow the safety precautions below will result in serious injury or death.



In the case of processing a significant unbalanced work, lower the rotation speed.

For All Users

- Unbalanced work generates dangerous centrifugal forces and the work could fly out.

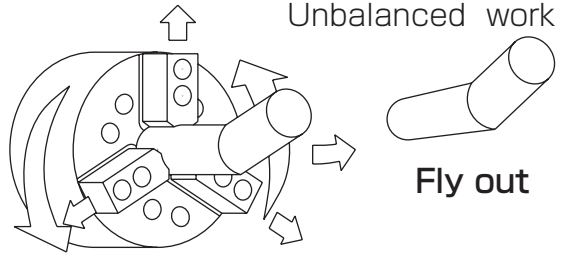

Always tighten the bolts at the specified torque. If the torque is insufficient or excessive, the bolt will break, which is dangerous as the chuck or work will fly out. Use the bolts attached to the chuck, and do not use bolts other than these.

For All Users

- If the torque is insufficient or excessive, the bolt will break, which is dangerous as the chuck or work will fly out.
- Fix the lathe spindle or the chuck when you tighten bolts. Your hand could slip and get injury when you work without fixing the spindle.
- You cannot control the torque by a hex key. You must use a torque wrench for torque control.

Specified torque for socket head cap screw

Bolt size	Tightening torque
M6	13 N·m
M8	33 N·m
M10	73 N·m
M12	107 N·m
M14	171 N·m
M16	250 N·m
M20	402 N·m
M22	539 N·m
M24	666 N·m

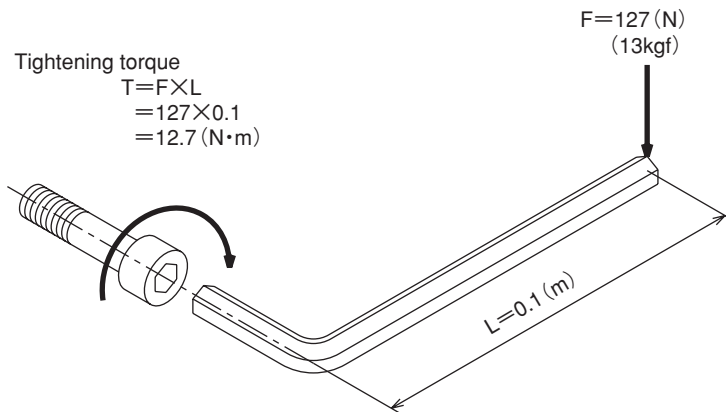

- Tightening torque is moment of force when you tighten a bolt. Tightening torque = $F \times L$.



DANGER

Failure to follow the safety precautions below will result in serious injury or death.



Provide sufficient strength for the draw bar (Refer to pages 38-39).
Provide sufficient screw depth for the draw bar.
Firmly tighten the draw bar.

For Machine Tool Manufactures

- If the draw bar break, the gripping force is instantly lost and this is dangerous as work will fly out.
- If the screw depth of the draw bar is insufficient, the screw will break and the gripping force will be lost instantly, and this is dangerous as work will fly out.
- If the engagement of the screw of the draw bar is loose, vibration may occur resulting in breakage of the screw. If the screw breaks, the gripping force will be lost instantly, which is dangerous as the work will fly out.
- If the draw bar is unbalanced, vibration occurs, the screw is broken and the gripping force will be lost instantly, which is dangerous as the work will fly out.

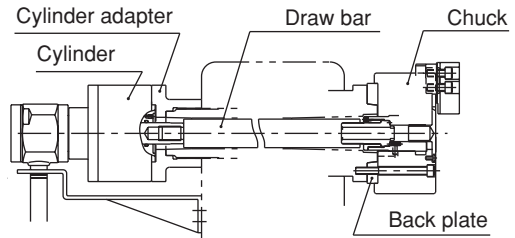

Use a cylinder with a lock valve (safety valve, check valve) incorporated in case of sudden hydraulic pressure drop due to blackout, malfunction of the hydraulic pump, etc. Further, use a solenoid valve with a circuit that retains the gripping position when no current is carried.

For Machine Tool Manufactures

- If the hydraulic pressure suddenly drops due to blackout or malfunction of the hydraulic pump, etc., this is dangerous as work will fly out.
- Lock valve retains the hydraulic pressure inside the cylinder temporarily, when the hydraulic pressure suddenly drops due to blackout or malfunction of the hydraulic pump, etc.

Lightning = Blackout

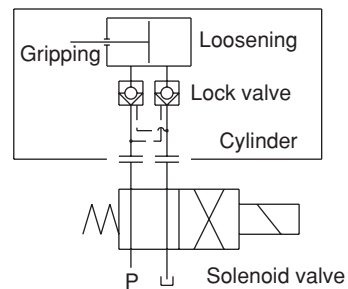
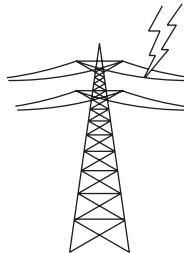

The gripping position must be retained.



WARNING

Failure to follow the safety precautions below could result in serious injury or death.



Do not modify the chuck in a way not permitted by the manufacturer.

For All Users

- It may not only break the chuck but the chuck and the work may fly out, which is dangerous.
- If you attach a locator or jig on the chuck body surface, only process work in an acceptable range (Refer to page 31).

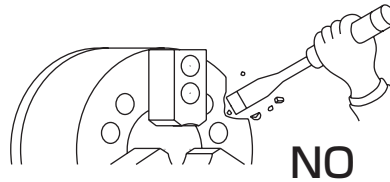

Periodically supply adequate grease (Refer to page 33). Turn off power before adding grease.

For All Users

- Insufficient grease supply lowers the gripping force, causes operation failure due to lower hydraulic pressure, lowers the gripping precision, and causes abnormal wearing and seizing, etc.
- This is dangerous as the work could fly out from a drop in the gripping force.

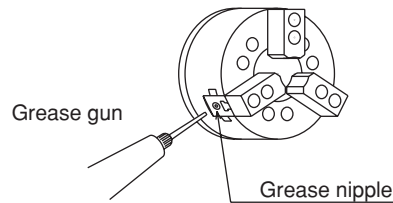

Do not operate the machine after drinking alcohol or taking medication.

For All Users

- Dangerous since these lead to operation mistakes and misjudgment.

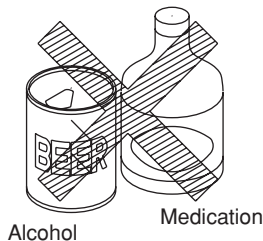

Alcohol

Medication



Do not operate the machine wearing gloves, a necktie, and other loose clothing or jewelry.

For All Users

- Dangerous since it will be caught.



Do not grip a chuck with a chuck.

For All Users

- Because it is easy to confuse the specifications of each chuck and the protrusion become long and is apt to raise rotation speed, it is apt to exceed the specifications of the base chuck. The chuck may break and the chuck or work could fly out.

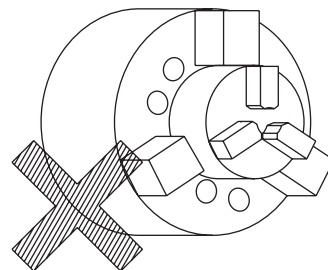

3. Specifications

3-1 Specifications

• N type

Table 2-1

Type		N-04	N-05	N-06	N-08	N-10
Plunger stroke	mm	15	15	20	21	25
Jaw stroke (in diameter)	mm	6.4	6.4	8.5	8.8	8.8
Allowable maximum input force	kN (kgf)	8.2 (836)	8.2 (836)	18 (1835)	25 (2549)	29 (2957)
Maximum static gripping force	kN (kgf)	22.8 (2325)	25.2 (2570)	52.5 (5353)	75 (7648)	108 (11013)
Allowable maximum rotation speed	min ⁻¹	6000	5500	5270	4760	4010
Standard soft jaw height (Z axis)	mm	27	29	35	42	46
Gripping range (outside diameter gripping)	mm	φ 6~110	φ 16~135	φ 15~165	φ 23~210	φ 24~254
Mass (standard soft jaw included)	kg	4.1	6.2	13	25	37
Moment of inertia	kg · m ²	0.008	0.015	0.045	0.138	0.300
Matching cylinder	Hydraulic	Y 0715R	Y 0715R	Y 1020R	Y 1225R	Y 1225R
	Air	AY1315R	AY1315R	AY1720R	AY2225R	AY2225R
Maximum Hydraulic pressure (with matching cylinder)	MPa (kgf/cm ²)	2.4 (24.5)	2.4 (24.5)	2.6 (26.5)	2.5 (25.5)	2.8 (28.6)
Balance quality (standard soft jaw not included)	G6.3					
Storing temperature / Operating temperature	-20~+50°C / -10~+40°C					

Reference: 1kN = 101.97kgf 1MPa = 10.197kgf/cm²

When storing this product, the product should be subjected to the antirust treatment and stored in a place free from wetting, condensation, or freeze.

• N type

Table 2-2

Type		N-12	N-15	N-18	N-21	N-24
Plunger stroke	mm	30	35	35	35	35
Jaw stroke (in diameter)	mm	10.5	16	16	16	16
Allowable maximum input force	kN (kgf)	41 (4181)	82 (8362)	82 (8362)	82 (8362)	82 (8362)
Maximum static gripping force	kN (kgf)	156 (15907)	249 (25391)	249 (25391)	273 (27838)	273 (27838)
Allowable maximum rotation speed	min ⁻¹	3380	3040	2710	1940	1760
Standard soft jaw height (Z axis)	mm	54	61	61	71	71
Gripping range (outside diameter gripping)	mm	φ 26~304	φ 72~381	φ 133~450	φ 69~530	φ 152~610
Mass (standard soft jaw included)	kg	57.3	96	124	180	223
Moment of inertia	kg · m ²	0.725	1.80	2.35	4.80	6.925
Matching cylinder	Hydraulic	Y 1530R	Y 2035R	Y 2035R	Y 2035R	Y 2035R
	Air	—	—	—	—	—
Maximum Hydraulic pressure (with matching cylinder)	MPa (kgf/cm ²)	2.7 (27.5)	3.2 (32.6)	3.2 (32.6)	3.2 (32.6)	3.2 (32.6)
Balance quality (standard soft jaw not included)	G6.3					
Storing temperature / Operating temperature	-20~+50°C / -10~+40°C					

Reference: 1kN = 101.97kgf 1MPa = 10.197kgf/cm²

When storing this product, the product should be subjected to the antirust treatment and stored in a place free from wetting, condensation, or freeze.

• N-A type

Table 3-1

Type		N-06A05	N-08A06	N-10A06	N-10A08	N-12A06	N-12A08	N-15A08	N-15A11
Plunger stroke	mm	20	21	25		30		35	
Jaw stroke (in diameter)	mm	8.5	8.8	8.8		10.5		16	
Allowable maximum input force	kN (kgf)	18 (1835)	25 (2549)	29 (2957)		41 (4181)		82 (8362)	
Maximum static gripping force	kN (kgf)	52.5 (5353)	75 (7648)	108 (11013)		156 (15907)		249 (25391)	
Allowable maximum rotation speed	min ⁻¹	5270	4760	4010		3380		3040	
Standard soft jaw height (Z axis)	mm	35	42	46		54		61	
Gripping range (outside diameter gripping)	mm	φ 15~165	φ 23~210	φ 24~254		φ 26~304		φ 72~381	
Mass (standard soft jaw included)	kg	14	27	40		67	66	105	103
Moment of inertia	kg · m ²	0.005	0.147	0.335	0.327	0.760	0.752	1.95	1.87
Matching cylinder	Hydraulic	Y 1020R	Y 1225R	Y 1225R		Y 1530R		Y 2035R	
	Air	AY1720R	AY2225R	AY2225R		—		—	
Maximum Hydraulic pressure (with matching cylinder)	MPa (kgf/cm ²)	2.58 (26.3)	2.48 (25.3)	2.84 (29.0)		2.81 (28.7)		3.10 (31.6)	
Balance quality (standard soft jaw not included)		G6.3							
Storing temperature / Operating temperature		-20~+50°C / -10~+40°C							

Reference: 1kN = 101.97kgf 1MPa = 10.197kgf/cm²

When storing this product, the product should be subjected to the antirust treatment and stored in a place free from wetting, condensation, or freeze.

• N-A type

Table 3-2

Type		N-18A08	N-18A11	N-21A08	N-21A11	N-21A15	N-24A11	N-24A15	
Plunger stroke	mm	35		35			35		
Jaw stroke (in diameter)	mm	16		16			16		
Allowable maximum input force	kN (kgf)	82 (8362)		82 (8362)			82 (8362)		
Maximum static gripping force	kN (kgf)	249 (25391)		273 (27838)			273 (27838)		
Allowable maximum rotation speed	min ⁻¹	2710		1940			1760		
Standard soft jaw height (Z axis)	mm	61		71			71		
Gripping range (outside diameter gripping)	mm	φ 133~450		φ 69~530			φ 152~610		
Mass (standard soft jaw included)	kg	134	131	201	198	190	241	234	
Moment of inertia	kg · m ²	2.47	2.42	5.17	5.12	4.97	7.37	7.05	
Matching cylinder	Hydraulic	Y 2035R		Y 2035R			Y 2035R		
	Air	—		—			—		
Maximum Hydraulic pressure (with matching cylinder)	MPa (kgf/cm ²)	3.10 (31.6)		3.10 (31.6)			3.10 (31.6)		
Balance quality (standard soft jaw not included)		G6.3							
Storing temperature / Operating temperature		-20~+50°C / -10~+40°C							

Reference: 1kN = 101.97kgf 1MPa = 10.197kgf/cm²

When storing this product, the product should be subjected to the antirust treatment and stored in a place free from wetting, condensation, or freeze.

• NT type

Table 4

Type		NT04	NT05	NT15
Plunger stroke	mm	15	15	35
Jaw stroke (in diameter)	mm	6.4	6.4	16
Allowable maximum input force	kN (kgf)	5.3 (540)	5.3 (540)	54.7 (5578)
Maximum static gripping force	kN (kgf)	15.2 (1550)	16.8 (1713)	166 (16927)
Allowable maximum rotation speed	min ⁻¹	6000	5500	3040
Standard soft jaw height (Z axis)	mm	27	29	61
Gripping range (outside diameter gripping)	mm	φ 7~110	φ 20~135	φ 80~381
Mass (standard soft jaw included)	kg	3.8	5.8	93
Moment of inertia	kg · m ²	0.007	0.013	1.79
Matching cylinder	Hydraulic	Y 0715R	Y 0715R	Y2035R
	Air	AY1315R	AY1315R	—
Maximum Hydraulic pressure (with matching cylinder)	MPa (kgf/cm ²)	1.68 (17.1)	1.68 (17.1)	2.1 (21.8)
Balance quality (standard soft jaw not included)	G6.3			
Storing temperature / Operating temperature	-20~+50°C / -10~+40°C			

Reference: 1kN = 101.97kgf 1MPa = 10.197kgf/cm²

When storing this product, the product should be subjected to the antirust treatment and stored in a place free from wetting, condensation, or freeze.

• NL type

Table 5

Type		NL04	NL06	NL08	NL10	NL12	NL18
Plunger stroke	mm	15	20	25	28	30	40
Jaw stroke (in diameter)	mm	12.1	13	16.2	18.1	19.4	26
Allowable maximum input force	kN (kgf)	10 (1020)	21 (2141)	30 (3059)	40 (4079)	54 (5506)	91 (9279)
Maximum static gripping force	kN (kgf)	14.4 (1468)	39 (3977)	60 (6118)	81 (8260)	111 (11300)	186 (18966)
Allowable maximum rotation speed	min ⁻¹	5000	4300	3600	3100	2500	2100
Standard soft jaw height (Z axis)	mm	27	35	42	46	54	61
Gripping range (outside diameter gripping)	mm	φ 9~110	φ 21~165	φ 21~210	φ 24~254	φ 29~304	φ 122~450
Mass (standard soft jaw included)	kg	4.1	12	22.9	34.6	60	124
Moment of inertia	kg · m ²	0.008	0.045	0.138	0.300	0.725	2.35
Matching cylinder	Hydraulic	Y 0715R	Y 1020R	Y 1225R	Y 1530R	Y 1530R	Y2050R
	Air	AY1315R	AY1720R	AY2225R	—	—	—
Maximum Hydraulic pressure (with matching cylinder)	MPa (kgf/cm ²)	2.9 (29.6)	3.0 (30.2)	2.9 (29.6)	2.8 (28.6)	3.6 (36.7)	3.5 (35.9)
Balance quality (standard soft jaw not included)	G6.3						
Storing temperature / Operating temperature	-20~+50°C / -10~+40°C						

Reference: 1kN = 101.97kgf 1MPa = 10.197kgf/cm²

When storing this product, the product should be subjected to the antirust treatment and stored in a place free from wetting, condensation, or freeze.

• NLT type

Table 6

Type		NLT06	NLT08	NLT10	NLT12
Plunger stroke	mm	20	25	28	30
Jaw stroke (in diameter)	mm	13	16.2	18.1	19.4
Allowable maximum input force	kN (kgf)	14 (1427)	20 (2039)	27 (2753)	36 (3671)
Maximum static gripping force	kN (kgf)	26 (2651)	40 (4078)	54 (5506)	74 (7546)
Allowable maximum rotation speed	min ⁻¹	4300	3600	3100	2500
Standard soft jaw height (Z axis)	mm	35	42	46	54
Gripping range (outside diameter gripping)	mm	φ 25~165	φ 26~210	φ 30~254	φ 36~304
Mass (standard soft jaw included)	kg	12.5	24	35.5	60.5
Moment of inertia	kg · m ²	0.043	0.133	0.293	0.708
Matching cylinder	Hydraulic	Y 1020R	Y 1225R	Y 1530R	Y 1530R
	Air	AY1720R	AY2225R	—	—
Maximum Hydraulic pressure (with matching cylinder)	MPa (kgf/cm ²)	2.06 (21.0)	2.03 (20.7)	1.93 (19.7)	2.50 (25.5)
Balance quality (standard soft jaw not included)		G6.3			
Storing temperature / Operating temperature		-20~+50°C / -10~+40°C			

Reference: 1kN = 101.97kgf 1MPa = 10.197kgf/cm²

When storing this product, the product should be subjected to the antirust treatment and stored in a place free from wetting, condensation, or freeze.

• NL-A type

Table 7

Type		NL06A05	NL08A06	NL10A06	NL10A08	NL12A06	NL12A08
Plunger stroke	mm	20	25	28		30	
Jaw stroke (in diameter)	mm	13	16.2	18.1		19.4	
Allowable maximum input force	kN (kgf)	21 (2141)	30 (3059)	40 (4079)		54 (5506)	
Maximum static gripping force	kN (kgf)	39 (3977)	60 (6118)	81 (8260)		111 (11319)	
Allowable maximum rotation speed	min ⁻¹	4300	3600	3100		2500	
Standard soft jaw height (Z axis)	mm	35	42	46		54	
Gripping range (outside diameter gripping)	mm	φ 21~165	φ 21~210	φ 24~254		φ 29~304	
Mass (standard soft jaw included)	kg	14.2	24.9	37.6		63	
Moment of inertia	kg · m ²	0.050	0.147	0.342	0.327	0.760	0.752
Matching cylinder	Hydraulic	Y 1020R	Y 1225R	Y 1225R		Y 1530R	
	Air	AY1720R	AY2225R	—		—	
Maximum Hydraulic pressure (with matching cylinder)	MPa (kgf/cm ²)	2.96 (30.2)	2.93 (29.9)	2.75 (28.0)		3.62 (36.9)	
Balance quality (standard soft jaw not included)		G6.3					
Storing temperature / Operating temperature		-20~+50°C / -10~+40°C					

Reference: 1kN = 101.97kgf 1MPa = 10.197kgf/cm²

When storing this product, the product should be subjected to the antirust treatment and stored in a place free from wetting, condensation, or freeze.

3-2 Relationship between gripping force and rotation speed

1. Maximum static gripping force

The static gripping force is the gripping force when the chuck is at a stop.

The power chuck has a mechanism to convert input force (piston thrust force, draw bar drawing force) from the cylinder to gripping force. Therefore, the gripping force when the allowable maximum input force becomes the maximum static gripping force.

However, the gripping force is different depending on the state of grease lubrication, grease in use, height of the jaw, etc. The maximum static gripping force specified in the specification is the value under the following conditions:

- The Kitagawa standard soft jaw is used as the jaw.
- The attaching bolts of the soft jaw are tightened at the specified torque. (Refer to page 9)
- The numerical values are obtained with the Kitagawa gripping force meter. The gripping position of the gripping force meter is at a position 1/2 of the height of the soft jaw top surface (height from the chuck surface to the top surface of the jaw).
- CHUCK GREASE PRO is used. (Refer to page 33).
- A variable displacement pump with the discharge volume of 20 liters/min or more is used as the hydraulic source. The pressure is set by the pressure control equipment of the pump itself, or the pressure reduction valve equipped separately.

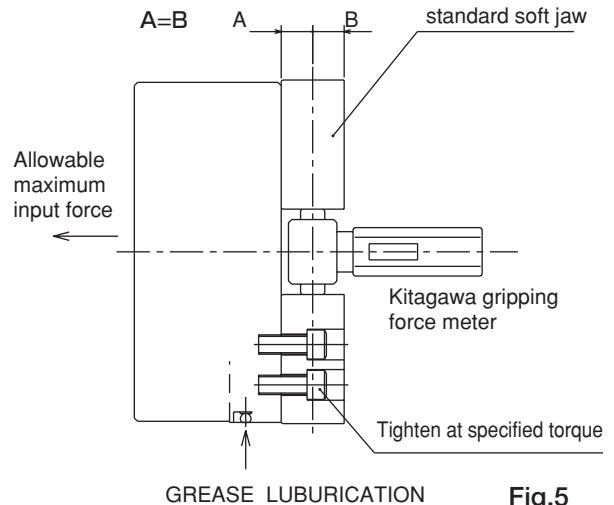

2. Allowable maximum rotation speed

In the case of outside diameter gripping, when the chuck is rotated, the gripping force lowers due to the centrifugal force of the top jaw. Therefore, the rotation speed when the dynamic gripping force (gripping force during rotation) becomes approximately 1/3 of the maximum static gripping force is set as the allowable maximum rotation speed. Actually measured values are indicated for models N ($N \cdot A$) and NT, and theoretical values for models NL ($NL \cdot A$) and NLT ($NLT \cdot A$). The centrifugal force is different depending on the mass of the top jaw and the barycentric position as well as the rotation speed. The allowable maximum rotation speed specified in the specification is the value under the following conditions:

- The Kitagawa standard soft jaw is used.
- Grip the gripping force meter in the center of the jaw stroke, and at this point, the soft jaw is attached at the position where the periphery side end of the soft jaw and the chuck periphery are almost lined up.
- The numerical values are obtained by the Kitagawa gripping force meter. The gripping position of the gripping force meter is at a position 1/2 of the height of the soft jaw top surface (height from the chuck surface to the top surface of the jaw).

⚠ DANGER

To avoid serious accidents caused by the chuck or work flying out:

- Determine the gripping force required for processing by the machine tool manufacturer or user, and check that the required gripping force is provided before processing. The gripping force of the chuck must not exceed the maximum static gripping force.
- Determine the rotation speed required for processing by the machine tool manufacturer or user based on the gripping force required for the processing. The rotation speed at this point must not exceed the allowable maximum rotation speed.

NOTICE

- When determining the cutting conditions, refer to pages 17-25.
- Pay attention since the gripping force is different depending on the state of the oil supply, grease in use, height of the jaw, performance of the pump and the pressure reducing valve, piping state, etc.

3. Relationship between gripping force and rotation speed

As the rotation speed becomes higher, the centrifugal force of the jaw increases and the gripping force lowers. The curves displayed in Fig. 6~9 shows relationships between the rotation speed and the centrifugal force when using the standard soft jaw. The centrifugal force differs significantly depending on the size and shape of the top jaw and the attaching position, therefore, when the rotation speed is high, actual measurement using a Kitagawa gripping force meter is required.

Fig.6 N type

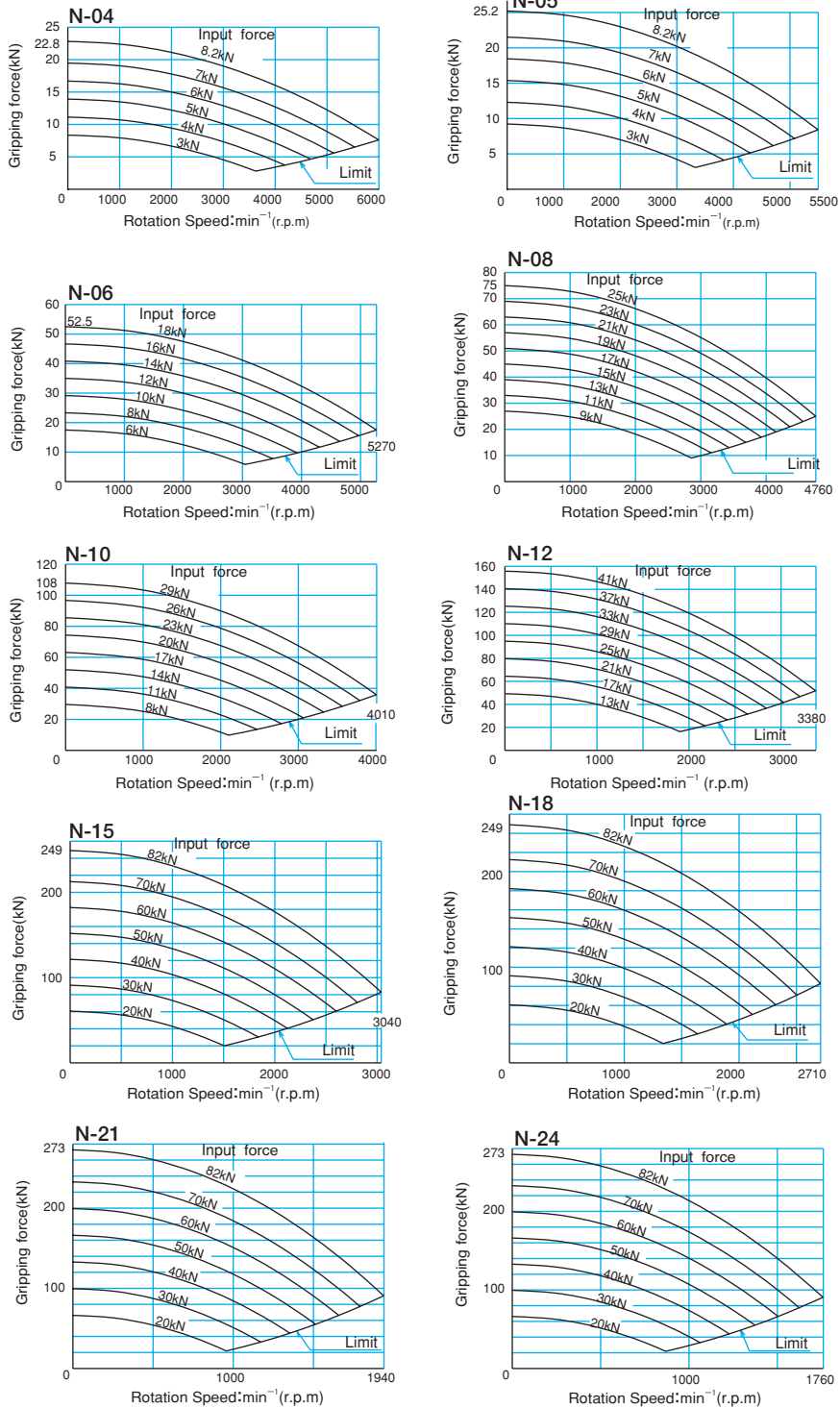

Fig.7 NT type

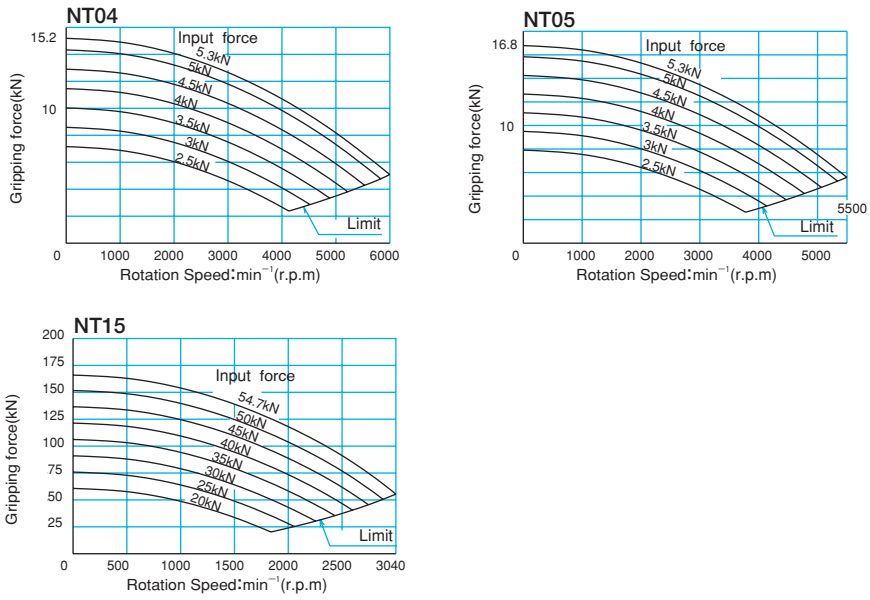

Fig.8 NL type

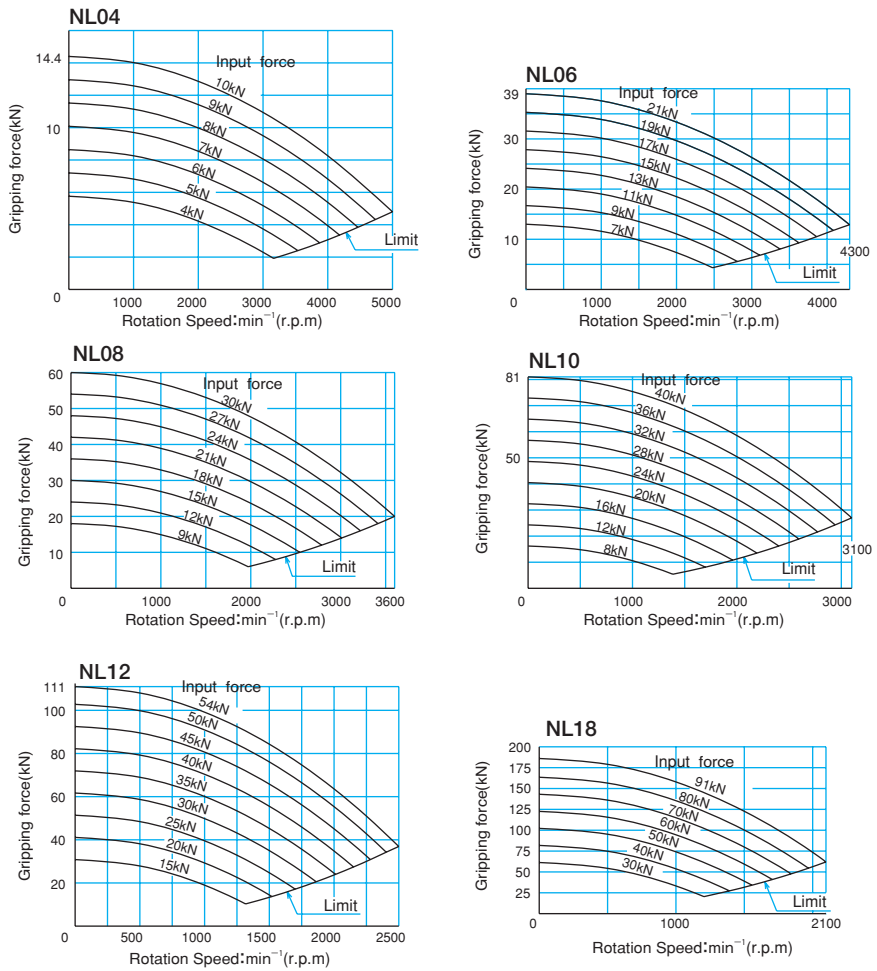
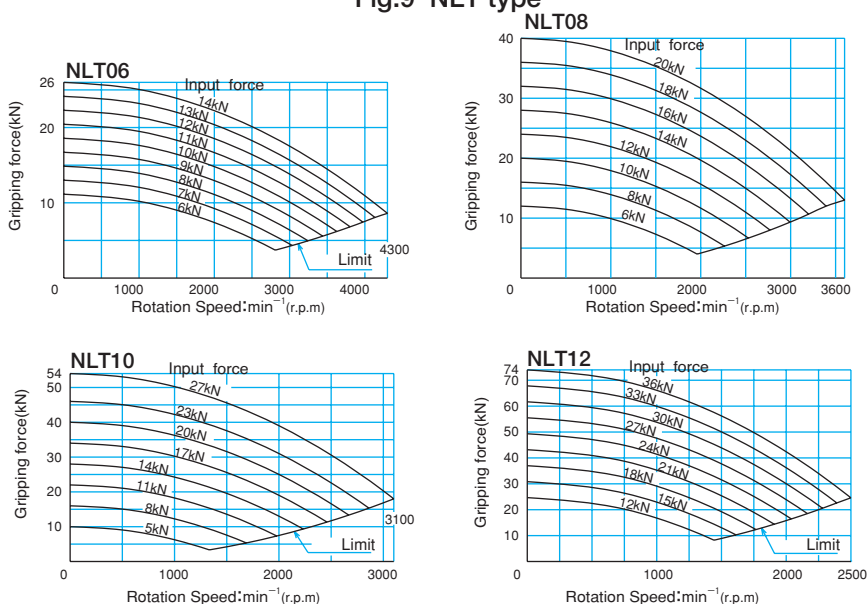

Fig.9 NLT type



- In the case of processing a considerably unbalanced work, lower the rotation speed. The work will fly out and this is dangerous.
- Vibration is generated if there is unbalance due to the work and the jig, etc. Vibration decreases process precision and shortens the working life of the chuck, even possibly breaking it. Correct the unbalance by using a balance weight, etc., or lower the rotation speed for use.
- In the case of heavy cutting at high rotation speed, vibration is easily generated in the same manner as the unbalance of the chuck, therefore, set the cutting conditions appropriate for the dynamic gripping force and machine rigidity.

3-3 Relationship between gripping part center height, static gripping force and input force / Relationship between top jaw mass moment and gripping force loss

If the gripping part center height of the used top jaw (dimension H in Fig. 10) is higher than the gripping part center height of the standard soft jaw, a large load is applied to the master jaw, T nut, jaw attaching bolts, etc. To prevent these parts from being broken, it is necessary to use the machine by using a lower input force than the allowable maximum input force. Additionally, if the top jaw is larger and heavier, the centrifugal force generated at the top jaw will increase. It is necessary to examine the dynamic gripping force considering the centrifugal force and to use the machine at a rotation speed that can withstand the cutting force.

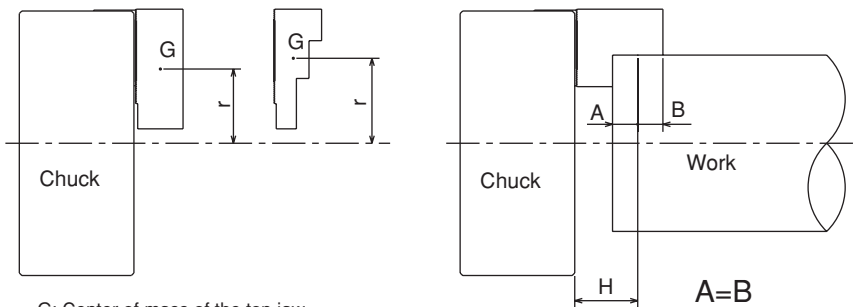

G: Center of mass of the top jaw
 m: Mass of the top jaw
 r : Distance from the center of mass of the top jaw to the chuck center
 H : Gripping center height

Fig.10



- Keep the height of the top jaw within the range of the gripping force limit table. (Refer to Fig.11-14)
- If a top jaw is taller than the standard soft jaw, use it at the input force (piston thrust force, draw bar drawing force) specified in the gripping force limit table. If it is used without lowering the input, the chuck will break and this is dangerous as the chuck and work will fly out.

Fig.11 N type

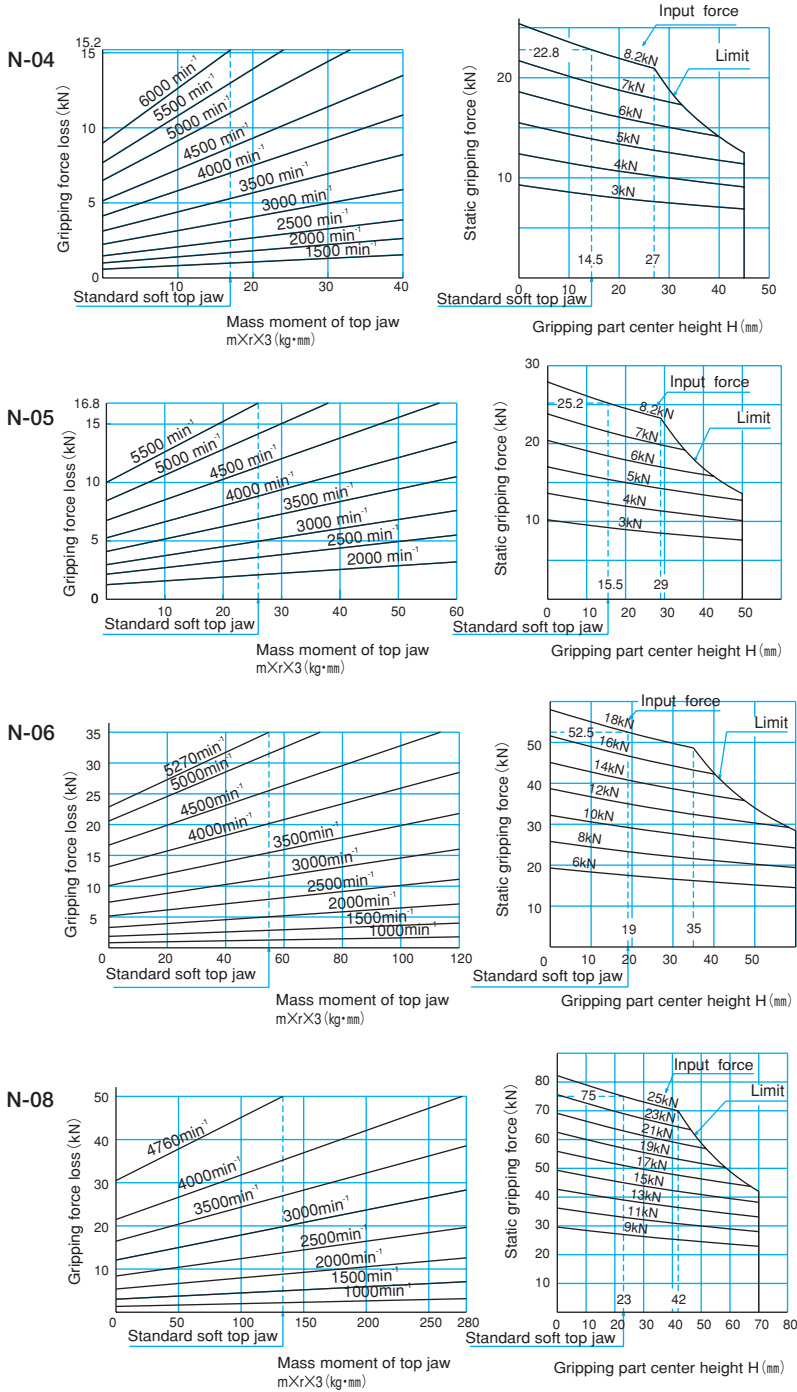

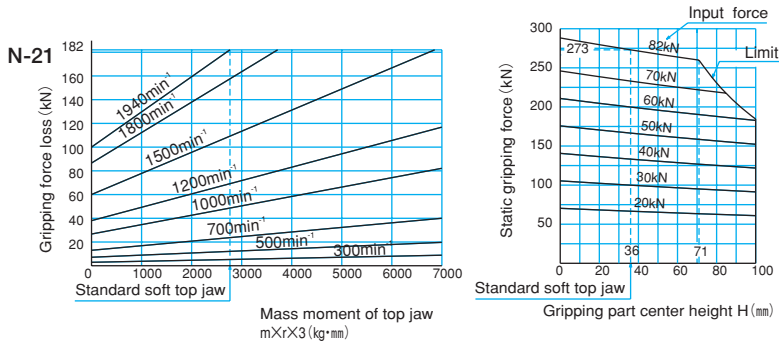
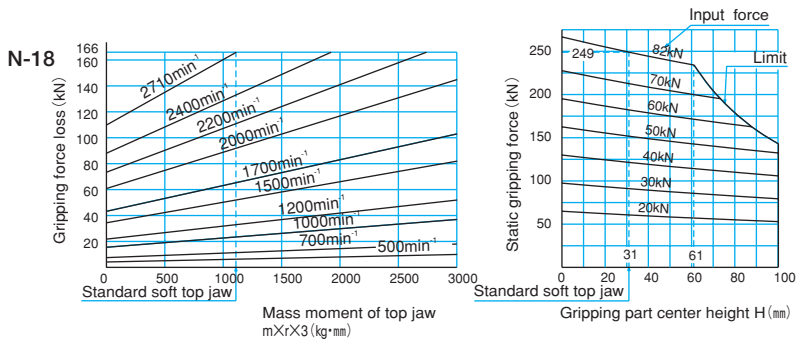
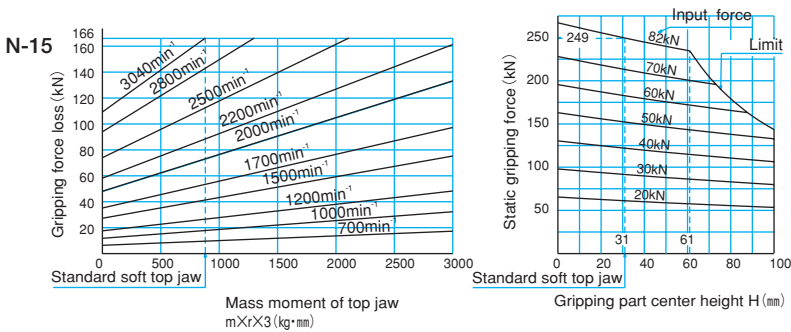
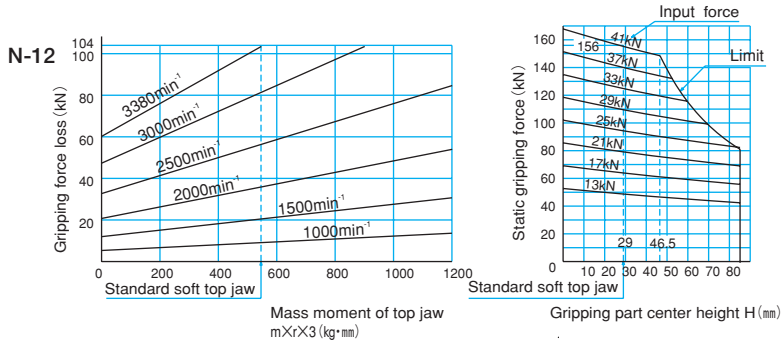
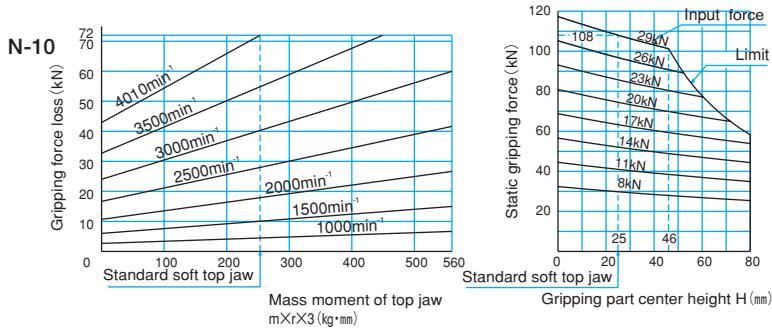

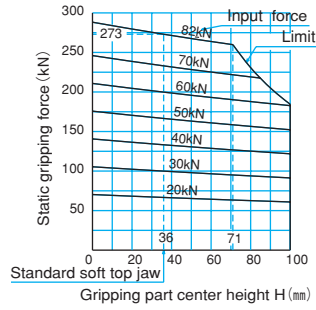
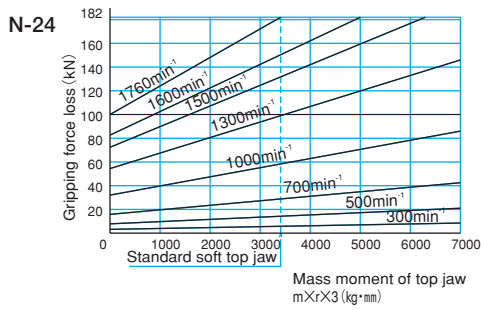

Fig.12 NT type

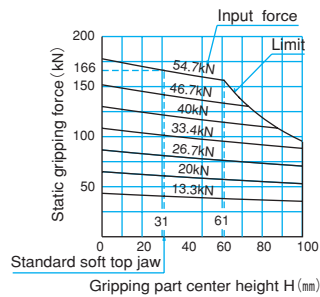
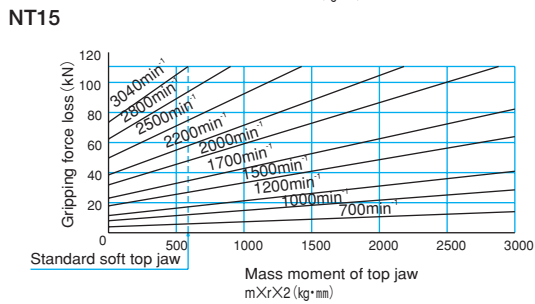
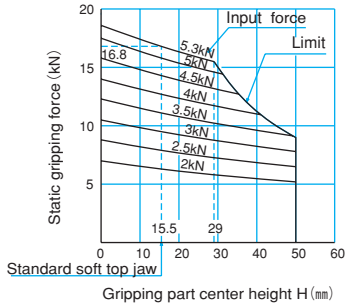
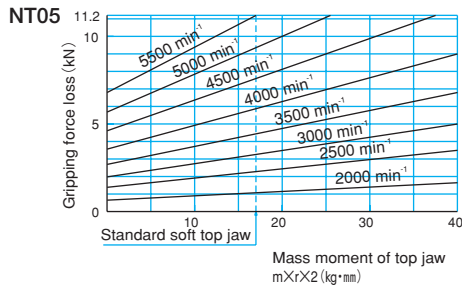
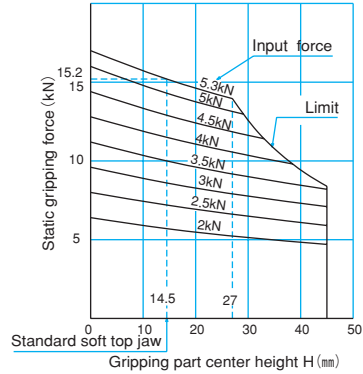
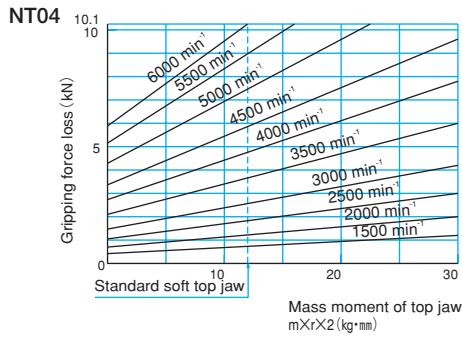
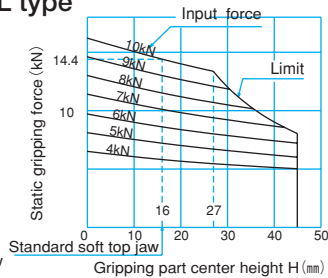
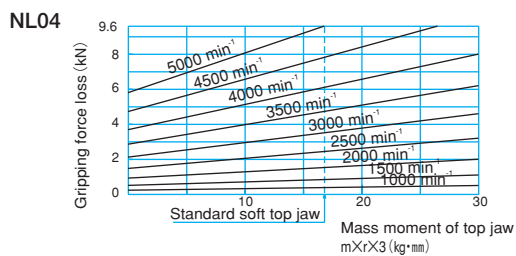
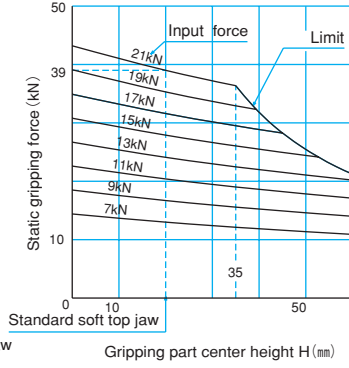
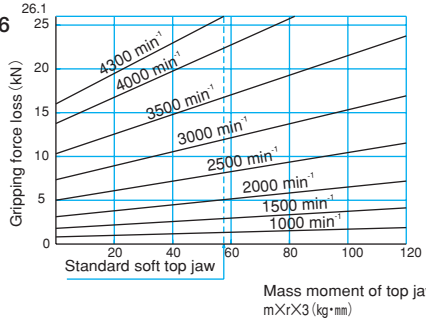

Fig.13 NL type



NL06



NL08

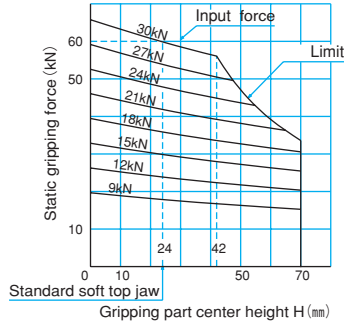
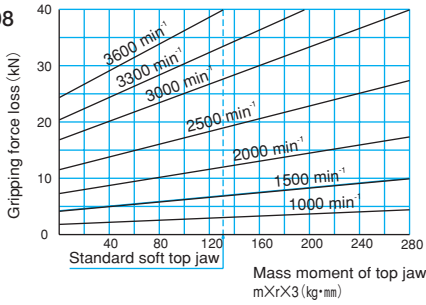

NL10

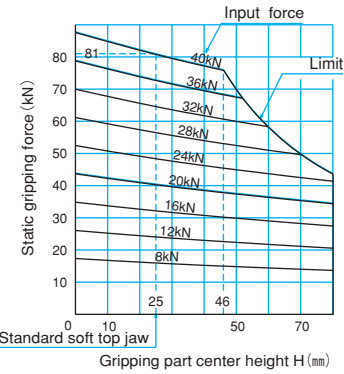
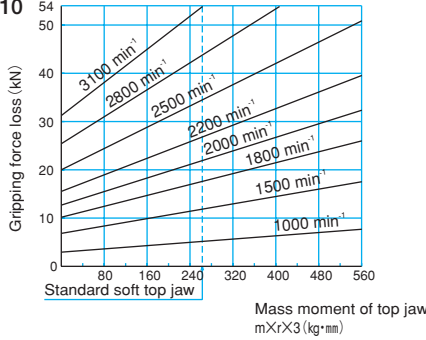

NL12

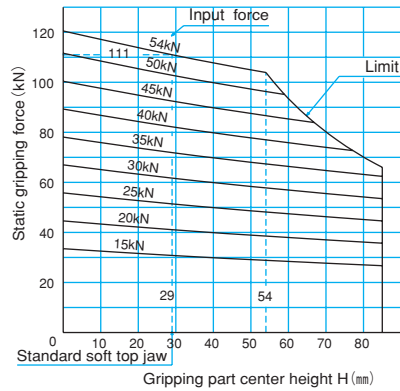
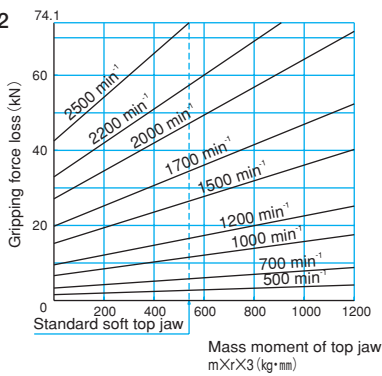

NL18

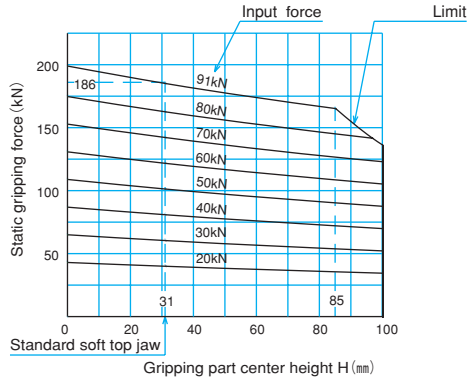
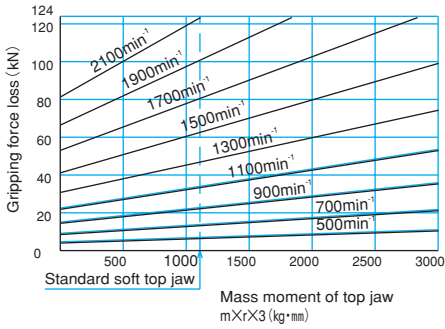
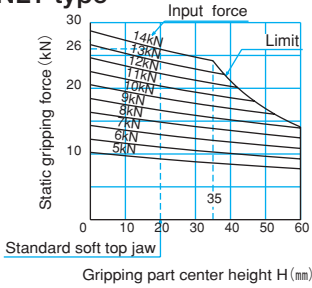
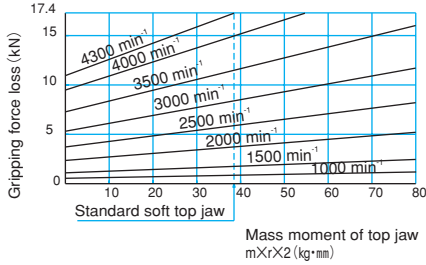
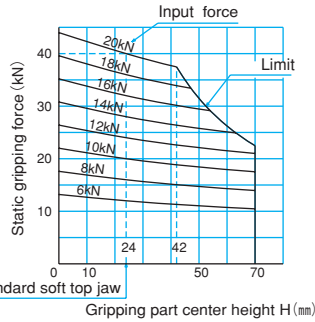
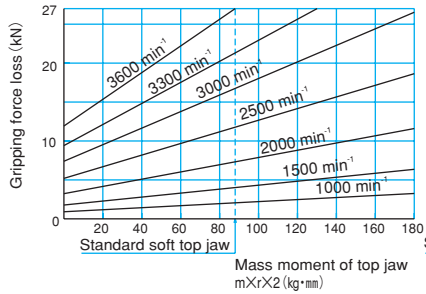

Fig.14 NLT type

NLT06



NLT08



NLT10

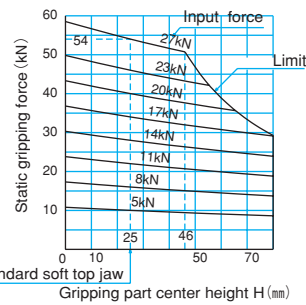
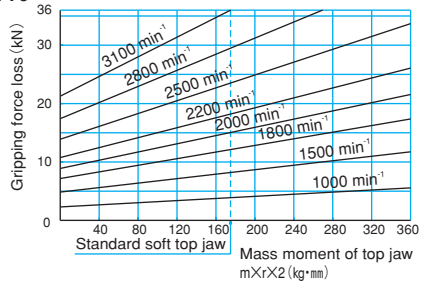

NLT12

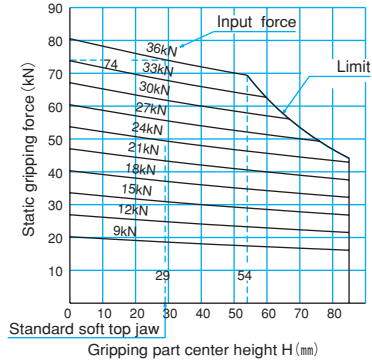
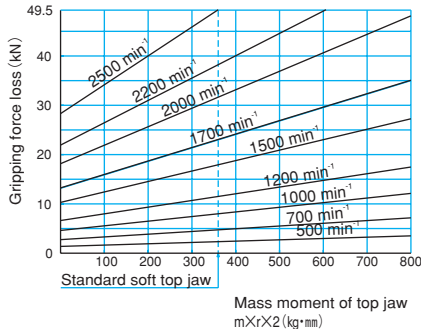

NOTICE

Analysis of the gripping force, input force and rotation speed using Fig. 11-14 is carried out as shown below.

- For example, in the case of N-04 standard soft jaw (mass moment $17\text{kg} \cdot \text{mm}$), it cannot exceed 6000min^{-1} (rpm), and the gripping force loss due to the centrifugal force at this rotation speed is 15.2kN (approx. 1550kgf). The required static gripping force for the dynamic gripping force (gripping force loss by static gripping force - centrifugal force) to become $1/3$ of the static gripping force is 22.8kN , and the required input to obtain this gripping force is 8.2kN . However, it is necessary to use at the gripping part center height $H=14.5\text{mm}$ or less.
- If the gripping part center height H is high, it is necessary to lower the static gripping force.
- If the top jaw mass moment is large, the rotation speed needs to be lowered.
- If the rotation speed is high, the gripping force loss due to the centrifugal force becomes large. The centrifugal force is proportional to the square of the rotation speed.

The required static gripping force and input force required at the rotation speed in use are predicted from Fig.11-14, however, it contains a number of hypothetical conditions. Therefore, it is necessary to only use these as reference, and the processing conditions must be determined after trial cutting without fail.



DANGER

- Reduce the allowable maximum input force of the 2 jaw chuck by $2/3$ in comparison with the 3 jaw chuck. (Refer to Table 4, 6) Otherwise the chuck will break, the work will fly out and this is dangerous.
- In the case of using only 1 jaw for gripping reduce the input force by $2/3$ or more with 3 jaw chuck. If 2 jaws are used for gripping reduce the input force by $1/3$ or more with 3 jaw chuck. If 1 jaw is used for gripping reduce the input force by $1/2$ or more with 2 jaw chuck. If it is used without lowering the input, the input which is normally applied evenly onto 3 of the jaws is concentrated onto 1 or 2 of the jaws. Otherwise the chuck will break, the work will fly out and this is dangerous.



WARNING

- In the case of inner diameter gripping, the input force needs to be lowered because the gripping force increase due to the centrifugal force. Otherwise the work will deform or break due to large gripping force, work will fly out and this is dangerous.

4 . Forming Soft Jaw

4-1 Attachment of soft jaw

The attaching position of the soft jaw can be adjusted by loosening the socket head cap screw, attaching the soft jaw and by changing each serration engagement position.

Use the most appropriate soft jaw considering the shape, dimension, material, and surface roughness of the work and the cutting conditions, etc.



- Use the T nut so that it does not come out from the master jaw. (Refer to Fig.15)
- If the T nut comes out from the master jaw, the master jaw and T nut will break causing the work to fly out and a possible precision failure.

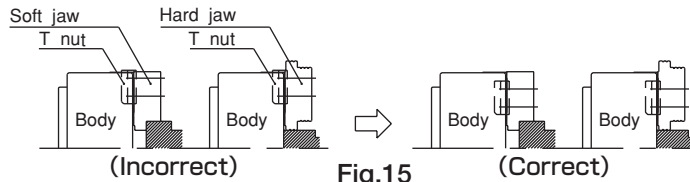

Fig.15

- Always tighten the bolts at the specified torque. If the torque is insufficient or excessive, the bolt will break, which is dangerous as the chuck or work will fly out.

Table 8

Bolt size	Tightening torque	Bolt size	Tightening torque	Bolt size	Tightening torque
M 6	13 N·m	M12	107 N·m	M20	402 N·m
M 8	33 N·m	M14	171 N·m	M22	539 N·m
M10	73 N·m	M16	250 N·m	M24	666 N·m



- If the screw-in depth of the jaw attaching bolt to the T nut is shallow, the T nut will break, and this is dangerous as the jaw and work will fly out. If the attaching bolt is too long and comes out from the bottom of the T nut as well, this is dangerous as the jaw and work will fly out since the top jaw is not fixed. Therefore, the overall length of the jaw attaching bolt must be approximately 0 to -1mm from the bottom of the T nut (Refer to Fig.16).
- Use the T nut and the attaching bolts attached to the chuck and do not use bolts other than these. If commercially available bolts are used for an unavoidable reason, use bolts at the strength classification 12.9 (strength classification 10.9 for M22 or more) or more, and pay sufficient attention to the length.
- Do not rotate the chuck so that the T nut is loosened causing the jaw to fly out.

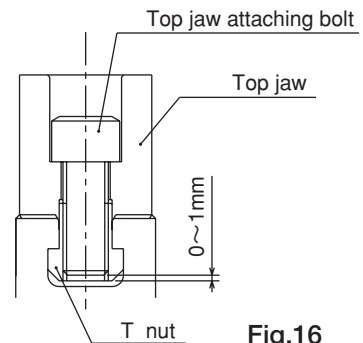

Fig.16

- Check that the reference mark on the side of the No. 1 master jaw is within the range of the entire stroke as shown in Fig. 17. Full stroke the jaw at least once a day to check it before work or when supplying grease, etc. If it goes out of the range of appropriate stroke due to loosening of the draw nut, etc., the work may not be gripped, and this is dangerous as the work will fly out.
- When gripping the work, use it by keeping the position of the master jaw within the appropriate stroke range. Gripping in the center of the stroke is the most stable for the mechanism, and the best precision can be obtained.
 - When gripping near the stroke end, the work may not be gripped sometimes according to the deviation, etc., of the gripping part allowance of the work, and this is dangerous as the work will fly out.
 - When gripping near the stroke end, the chuck may break and the chuck or work could fly out.

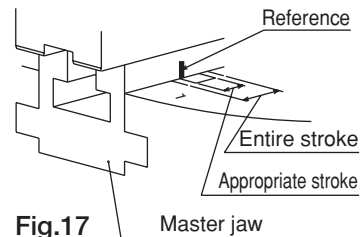
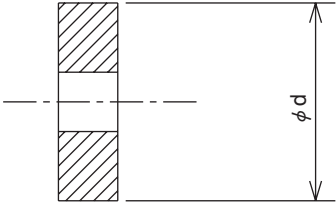
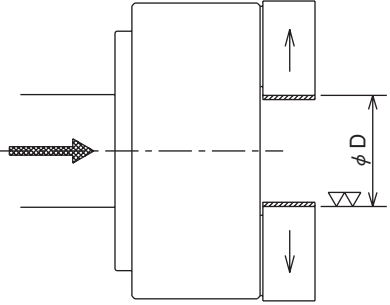
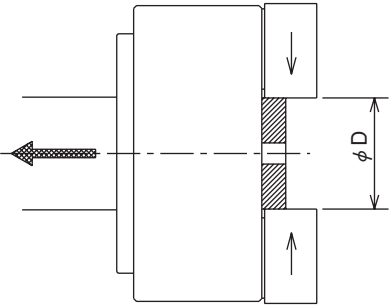
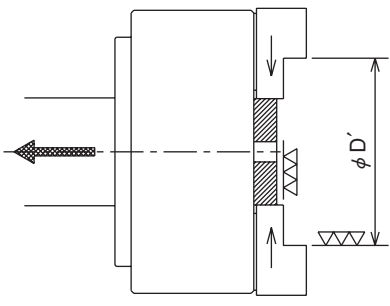
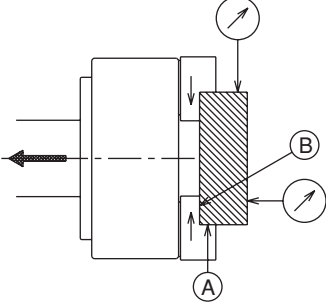

Fig.17

Table 9

Type	N-04 NT04 N-05 NT05	N-06 N-08 N-10	N-12	NL04 NL06 NL06 NL06 NL08	N-15 NT15 N-18 N-21 N-24	NL10 NLT10	NL12 NLT12	NL18
Appropriate stroke range (mm)	1.6	2.3	3.0	4.0	5.0	5.6	6.0	10.0

4-2 Forming soft jaw with outside diameter gripping

<p>1 . Preparation of the plug for forming</p> <ul style="list-style-type: none"> • Prepare the plug for forming. The surface roughness of the plug outside diameter is to be approximately 25s, and make a shape with sufficient thickness which does not distort. • It is convenient to prepare various outside diameter dimensions for dimensions of forming parts. • It is convenient to process tapping in the center part of the plug and to guide with a bolt, etc. 	
<p>2 . Process of the plug gripping part for forming</p> <ul style="list-style-type: none"> • Operate the switch valve and maximize the opening of the jaw. • Then, process the ϕD part (part to grip the plug for forming). Set the dimension ϕD so that gripping near the center of the jaw maximum stroke (diameter) is possible. • $\phi D = \phi d + (\text{jaw maximum stroke}/2)$ 	
<p>3 . Gripping of the plug for forming</p> <ul style="list-style-type: none"> • By operating the switch valve, grip the plug for forming in the ϕD part. At this time, grip by pressing the plug on the chuck front surface in order for the plug not to be tilted. Repeat chucking several times to stabilize the plug. 	
<p>4 . Forming</p> <ul style="list-style-type: none"> • Process the gripping part (dimension $\phi D'$) of the work in the state that the plug is kept gripped. The $\phi D'$ part is to be approximately the same diameter (H7) as the diameter of the gripping part of the work, and process to be surface roughness at 6s or less. • Set the hydraulic pressure during forming the same as during processing of the work, or slightly higher. • When the plug distorts, lower the hydraulic pressure or change the plug into a shape which does not easily distort. 	
<p>5 . Trial cutting</p> <ul style="list-style-type: none"> • Remove the plug for forming and grip the work to check the jaw stroke. • Implement trial cutting to check the process precision and that there is no slip, etc. • Contacting on the gripping surface is to be 2 points contact of the side A and the side B when gripping. 	

4-3 Forming soft jaw with inside diameter gripping

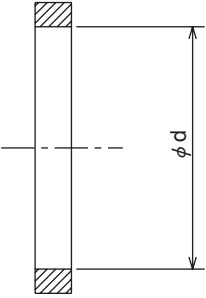
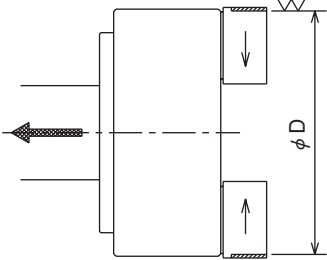
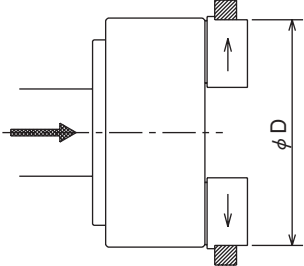
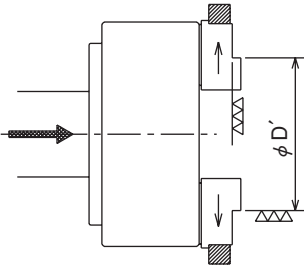
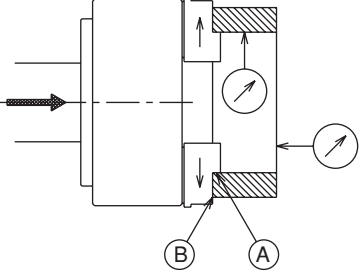
<p>1 . Preparation of the ring for forming</p> <ul style="list-style-type: none"> • Prepare the ring for forming. The surface roughness of the ring inside diameter is to be approximately 25s, and make a shape with a sufficient thickness which does not distort. • It is convenient to prepare various inside diameter dimensions for dimensions of forming parts. 	
<p>2 . Process of the ring gripping part for forming</p> <ul style="list-style-type: none"> • Operate the switch valve and minimize the jaw to close. • Then, process the ϕD part (part to grip the ring for forming). Set the dimension ϕD so that gripping near the center of the jaw maximum stroke (diameter) is possible. • $\phi D = \phi d - (\text{jaw maximum stroke}/2)$ 	
<p>3 . Gripping of the ring for forming</p> <ul style="list-style-type: none"> • By operating the switch valve, grip the ring for forming in the ϕD part. At this time, grip by pressing the ring on the jaw in order for the ring not to be tilted. Repeat chucking several times to stabilize the ring. 	
<p>4 . Forming</p> <ul style="list-style-type: none"> • Process the gripping part (dimension $\phi D'$) of the work in the state that the ring is kept gripped. The $\phi D'$ part is to be approximately the same diameter (H7) as the diameter of the gripping part of the work, and process to be surface roughness at 6s or less. • Set the hydraulic pressure when forming the same as when processing the work, or slightly higher. • When the ring distorts, lower the hydraulic pressure or change the ring into a shape which does not easily distort. 	
<p>5 . Trial cutting</p> <ul style="list-style-type: none"> • Remove the ring for forming and grip the work to check the jaw stroke. • Implement trial cutting to check the process precision and that there is no slip, etc. • Contacting on the gripping surface is to be 2 points contact of the side A and the side B when gripping. 	

4-4 Forming method when you use forming jig

<p>1 . Preparation of the jig for forming</p> <ul style="list-style-type: none"> • Prepare the jig for forming. (There is a commercially available product.) • Attach the pin (Example 1) or the bolt and nut (Example 2) by dividing equally into 3 portions onto the ring shape plate. Make the ring into a shape with sufficient thickness which does not distort. 	
<p>2 . Gripping of the jig for forming</p> <ul style="list-style-type: none"> • Operate the switch valve and maximize the opening of the jaw. Then, operate the switch valve to insert the jig for forming into the bolt hole of the soft jaw to grip. At this time, grip by pressing the ring end surface of the jig for forming onto the jaw so as not to generate run-out. • Check that it is gripping almost in the center of the appropriate stroke. • Set the hydraulic pressure when forming slightly higher than when processing the work. 	
<p>3 . Forming</p> <ul style="list-style-type: none"> • Process the gripping part (dimension $\phi D'$) of the work in the state that the jig for forming is kept gripped. The $\phi D'$ part is to be approximately the same diameter (H7) as the diameter of the gripping part of the work, and process to be surface roughness at 6s or less. 	
<p>4 . Trial cutting</p> <ul style="list-style-type: none"> • Remove the jig for forming and grip the work to check the jaw stroke. • Implement trial cutting to check the process precision and that there is no slip, etc. • Contacting on the gripping surface is to be 2 points contact of the side A and the side B when gripping. 	

5 . Usage

This product is a device to fix a work-piece when it is processed by the lathe machine or the rotary table. The rotary cylinder closes the jaw and fixes a work-piece so that it does not move during processing. The chuck opens the jaw after having processed it and remove a work-piece.

NOTICE

- When replacing the top jaw, carefully clean the serration part with the master jaw, and the engagement part of the T nut. Failure to do this may cause a precision failure.
- Set the hydraulic pressure according to the shape of the work and the cutting conditions. Pipe shape work, etc., may be distorted if they are tightened at a high gripping force.

5-1 Precautions during gripping work with chuck

DANGER

- When gripping a work with the chuck, do not get fingers or hands become caught. This could cause crushed or cut fingers and hands.

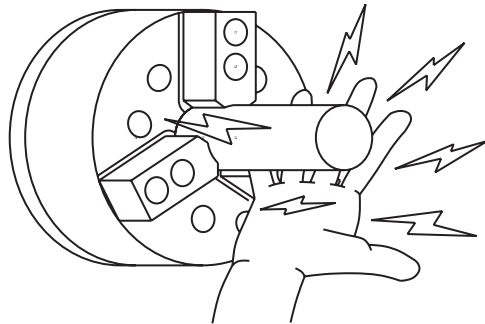

5-2 Precautions during gripping work in irregular shape

DANGER

- If a work in an irregular shape is gripped the master jaw may be broken. Consult our company or the distributor if there is any concern.
- Cast metal, pitched shape or taper shape cannot be gripped.
- If the protrusion of the work is long, support it with a center or the steady rest. If the protrusion is long the tip of the work turns, and this is dangerous as the work will fly out.

5-3 Precautions related to usage of jaw

DANGER

- If a soft jaw other than one made by Kitagawa Corporation is used, the engagement will be inferior, and the master jaw will be deformed, the gripping precision will worsen, and the work will fly out due to gripping failure, which is dangerous.
- Do not use a top jaw with a different serration pitch from the master jaw. The engagement of the crests of the serration will become insufficient, therefore, the serration crests will break when gripping the work, and this is dangerous as the jaw and work will fly out.
- Do not use the soft jaw by welding to join for extension. The jaw will break due to insufficient strength and the serration part will become distorted due to welding. As a result, the engagement will worsen, the serration crests will break, and this is dangerous as the work will fly out.

5-4 Precautions related to processing

⚠ DANGER

<1> Unbalance

- In the case of processing largely unbalanced work, lower the rotation speed. The work will fly out and this is dangerous.
- Vibrations are generated if there is unbalance owing to the work or the jig, etc. Vibration not only will impart a negative influence on the process precision but also the endurance of the chuck being remarkably shortened, and the chuck may break. Correct the unbalance using balance weights, etc., or lower the rotation speed for use.
- Heavy cutting at high rotation speed easily generates vibration in the same manner as chuck unbalance, therefore, set cutting conditions appropriate for the dynamic gripping force and machine rigidity.

<2> Interference, contact, impact

- Before starting work, check that the top jaw, locator, work, etc., and the tool and the tool post, etc., do not interfere at low rotation and then start processing.
- Do not allow anything to impact the chuck, jaw, and the work. The chuck will break and this is dangerous as the chuck and work will fly out.
- If the tool and the tool post contact the chuck or the work due to malfunction or tape mistake, etc., and impact is given, immediately stop the rotation, and check that there are no abnormalities in the top jaw, master jaw, T nut and bolts of each part, etc.

<3> Coolant

- Unless coolant with a rust preventive effect is used, rust will occur inside the chuck and gripping force drop may result. The work will fly out due to the gripping force drop and this is dangerous.

5-5 Attachment of locator and jig

- In the case of attaching the locator and the jig on the chuck body surface, tap or drill a hole in the additional process range specified in Fig. 18.

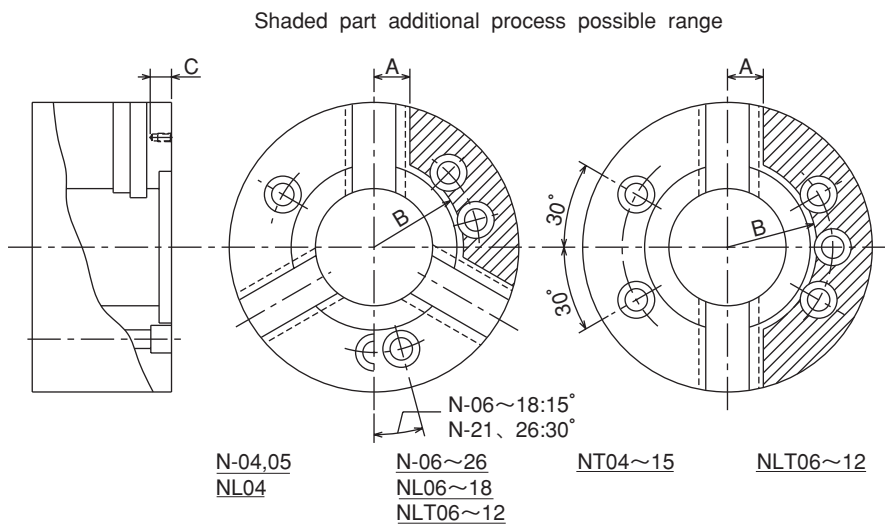

Fig.18

Table 10

Type	A (mm)	B (mm)	C (mm)
N-04, NL04, NT04	22	37	15 or less
N-05, NT05	22	44	15 or less
N-06, NL06, NLT06	26	55	20 or less
N-08, NL08, NLT08	29	60	20 or less
N-10, NL10, NLT10	34	67	20 or less
N-12, NL12, NLT12	40	80	20 or less
N-15, NT15	53	90	30 or less
N-18, NL18	53	119	30 or less
N-21	53	98	30 or less
N-24	53	137	30 or less

A, B: Additional process impossible dimension. C: Processible depth of tapping or drilling a hole.



- The chuck can be modified only in the manufacturer permissible range. This will not only break the chuck but the chuck and work may fly out, which is dangerous.
- Provide a countermeasure against flying out (dwell pin, etc.) due to centrifugal force to the locator or the jig, and attach with bolts which have sufficient strength. The locator or the jig may fly out, and this is dangerous.

6. Maintenance and Inspection

6-1 Periodic Inspection

- Add grease at least once a day.
- Fully stroke the jaw before starting work or upon supplying grease, and check that the jaw is inside the appropriate stroke area. (Refer to page 26)
- Always clean the chuck body or the sliding surface using an air gun, etc., at the end of work.
- Check that the bolts of each part are not loosened at least once every 3 months.
- Disassemble and clean at least once every 6 months or every 100,000 strokes (once every 2 months or more for cutting cast metal).

6-2 Grease lubrication

1. Position to lubricate

- Lubricate using a grease gun from the grease nipple on the body periphery part or each master jaw periphery part. Supply grease when the jaw is open. After lubrication, repeat opening and closing the jaw several times without gripping work.

2. Grease to use

- Use the designated grease specified in Table 11. If grease other than the designated grease is used, sufficient effect may not be obtained.

Table 11

Genuine product	CHUCK GREASE PRO	Kitagawa genuine product (Kitagawa distributor of each country)
Conventional product	Kitagawa chuck grease	Conventional product
	Molykote EP Grease	TORAY Dow Corning (only inside Japan)
	Chuck EEZ grease	Kitagawa-Northtech Inc. (North American region)
	MOLYKOTE TP-42	Dow Corning (Europe, Asian region)
	Kluberpaste ME31-52	Kluber lubrication (worldwide)

3. Frequency of lubrication

- Add grease once every day.
- Add approximately 5g up to 8 inches and 10g for 10 inches or larger of grease to the each master jaw. Check the filling degrees of the grease after removing the cover of the chuck center.
- In the case of high rotation or in the case of using a large amount of water soluble coolant, increase the frequency of lubrication according to the usage conditions.



- To keep the chuck running in the best condition for a long time, adequate grease lubrication is necessary. Insufficient grease lubrication causes a drop in the gripping force, operation failure at low hydraulic pressure, drop in gripping precision, abnormal wearing, seizing, etc. The work will fly out due to a drop in the gripping force and this is dangerous.

4. Safety information about grease and anti-rust oil

Applicable range

- Designated grease
- Antirust agent applied to the product at the delivery.

First aid measures

After inhalation: Remove victim to fresh air. If symptoms persist, call a physician.

After contact with skin: Wash off with mild cleaners and plenty of water. If symptoms persist, call a physician.

After contact with eyes: Rinse with plenty of water. If symptoms persist, call a physician.

After ingestion: If large amounts are swallowed, do not induce vomiting. Obtain medical attention.

- Please refer to each MSDS about the grease and the anti-rust oil which you prepared.

6-3 Disassembling

Disassembling procedures

Read the following disassembling procedures with reference to page 5.

1. Turn off the main power of the machine before starting work.
2. Loosen the jaw attaching bolt [15] and remove the soft jaw [4] and the T nut [5].
3. Loosen the socket head cap screw (or machine screw) [14] and remove the cover [6].
4. Remove the stop bolt [12].
5. Loosen the set screw [16] and remove lead ball [11] (Save these parts carefully because they are small.). Loosen the draw tube [8] and remove it from the wedge plunger [2]. (4" and 5" : The draw tube is not provided.)
6. Remove the wedge plunger [2] to the body [1] rear side.
7. Remove the master jaw [3] to the outer periphery side of the chuck.
8. The draw screw [7] is assembled in the draw tube [8] to adjust the plunger position. Usually the draw screw may not disassemble. Read the following procedures if it is disassembled.
Loosen the set screw [17] on the draw nut [9], and remove the draw nut [9] from the draw screw [7]. Save the steel ball [19] and the spring [10] carefully.

Assembling procedures

Read the following assembling procedures with reference to page 5.

Assemble again while sufficiently coating the recommended grease in the reverse procedures of disassembling. At this time, pay sufficient attention so as not to make a mistake in the numbers of the body [1], master jaw [3], and the wedge plunger [2].

Read the following procedures when you assemble draw screw. (Refer to Fig.19)

1. Install the draw screw [7] to draw tube [8] (4" and 5" : Plunger [2]).
2. Put the spring [10] and the steel ball [19] in a hole of the draw tube [8] (4" and 5" : draw nut [9]).
3. Install the draw nut [9] to the draw screw [7].
4. Slightly loosen the draw nut [9] from the tightened situation and adjust the clearance between the draw nut and draw tube [8] (4" and 5" : plunger [2]). Proper clearance: 0.05~0.15.
5. Screw the set screw [17]. Sufficiently screw the set screw onto the draw screw [7] at the recommended torque of 1.3 ~1.4 times.
6. Stake the set screw to prevent loosening.

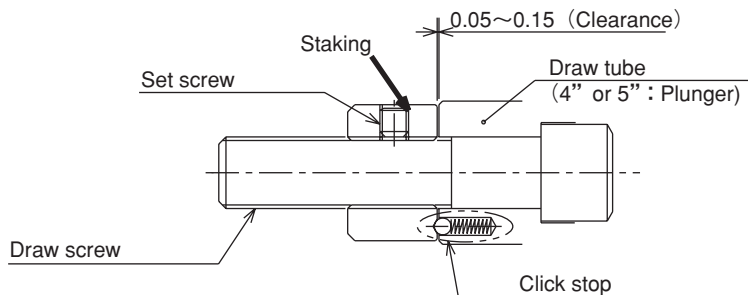
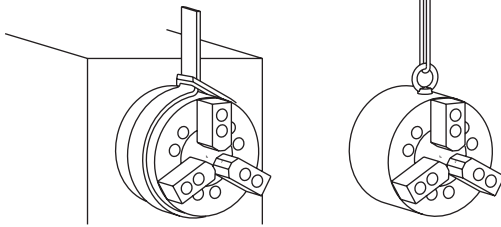

Fig.19

CAUTION

- Use an eyebolt or a hanging belt when attaching and detaching the chuck to and from the machine, as there is a danger of injury or damage if the chuck drops.



Chuck size(inch)	Eyebolt
4~5"	none
6~10"	M10
12~15"	M12
18~24"	M16

WARNING

- Remove the eyebolt or the belt without fail after using. If the chuck is rotated with the eyebolt, etc., attached, they may fly out and this is dangerous.
- Disassemble and clean the chuck at least once every 6 months or every 100,000 strokes (once every 2 months or more for cutting cast metal). If cutting powder or other substances stagnate inside the chuck, it will lead to insufficient stroke and a drop in the gripping force, and this is dangerous as the work will fly out. Check each part carefully and replace any part that is worn or cracked.
- After inspection, apply sufficient grease in the designated areas and reassemble.
- After assembling, measure the gripping force according to the method on page 16, and check that the specified gripping force is obtained.
- If you stop the machine for a long period of time, remove the work from the machine. If you don't, the work can drop due to a drop in the hydraulic pressure or the cylinder can stop or malfunction.
- If you stop the machine or store the chuck for a long period of time, add grease to prevent rust.

7 . Malfunction and Countermeasures

7-1 In the case of malfunction

Check the points specified in the table below and take the appropriate countermeasure.

Table 12

Defective	Cause	Countermeasure
The chuck does not operate.	The chuck inside will break.	Disassemble and replace the broken part.
	The sliding surface is seized.	Disassemble, correct the seized part with oilstone, etc., or replace the part.
	The cylinder is not operating.	Check the piping and the electric system, and if there is no abnormality, disassemble and clean the cylinder.
Insufficient stroke of the jaw.	A large amount of cutting powder is inside.	Disassemble and clean.
	The draw bar loosened.	Remove the draw bar and retighten it again.
The Work slips.	The stroke of the jaw is insufficient.	Adjust so that the jaw is near the center of the stroke when gripping the work.
	The gripping force is insufficient.	Check that the correct hydraulic pressure is obtained.
	The forming diameter of the top jaw is not consistent with the work diameter.	Form again based on the correct forming method.
	The cutting force is too large.	Calculate the cutting force and check that it is suitable for the specification of the chuck.
	Insufficient grease lubrication	Supply grease from the grease nipple, and open and close the jaw several times without gripping a work.
	The rotation speed is too high. Swinging occurs due to incorrect alignment of cores of work feeder, steady rest, tail stock, etc.	Lower the rotation speed to a speed at which the required gripping force can be obtained. Align the cores sufficiently to eliminate such swinging.
Precision failure.	The outer periphery of the chuck is running out.	Check the end surface run-out and the outer periphery, and retighten the chuck attaching bolts.
	Dust is attached on the serration part of the master jaw and the top jaw.	Remove the top jaw, and clean the serration part thoroughly.
	The attaching bolt of the top jaw is not tightened sufficiently.	Tighten the top jaw attaching bolt at the specified torque. (Refer to page 26)
	The forming method of the soft jaw is inappropriate.	Is the plug for forming parallel to the chuck end surface? Is the plug for forming not deformed due to the gripping force?
	The height of the top jaw is too high, the top jaw is deformed, the top jaw attaching bolt is elongated.	Lower the height of the top jaw. (Replace it with the standard size) or check the gripping contact surface and make it uniform.
	The gripping force is too large leading to the work being deformed.	Lower the gripping force in the range possible to process to prevent deformation.

WARNING

- If the chuck failed due to a seizure or breakage, remove the chuck from the machine, following the disassembly steps in page 34. When the jaws and covers cannot be removed due to a blockage of workpiece, do not disassemble forcibly but please contact us or our agent.
- If these countermeasures do not correct the problem or improve the situation. Immediately stop using the machine. Continuous use of a broken product or a defective product may cause a serious accident by the chuck or the work flying out.
- Only experienced and trained personnel should do repairs and fix malfunctions. Repair of a malfunction by a person who has never received instruction from an experienced person, the distributor or our company may cause a serious accident.

7-2 Where to contact in the case of malfunction

In the case of malfunction, contact the distributor where you purchased the product or our branch office listed on the back cover.

For Machine Tool Manufactures

Following pages are described for machine tool manufacturers (personnel who attach a chuck to a machine). Please read following instruction carefully when you attach or detach a chuck to machine, and please sufficiently understand and follow the instructions for safe operation.

8 . Attachment

8-1 Outline drawing of attachment

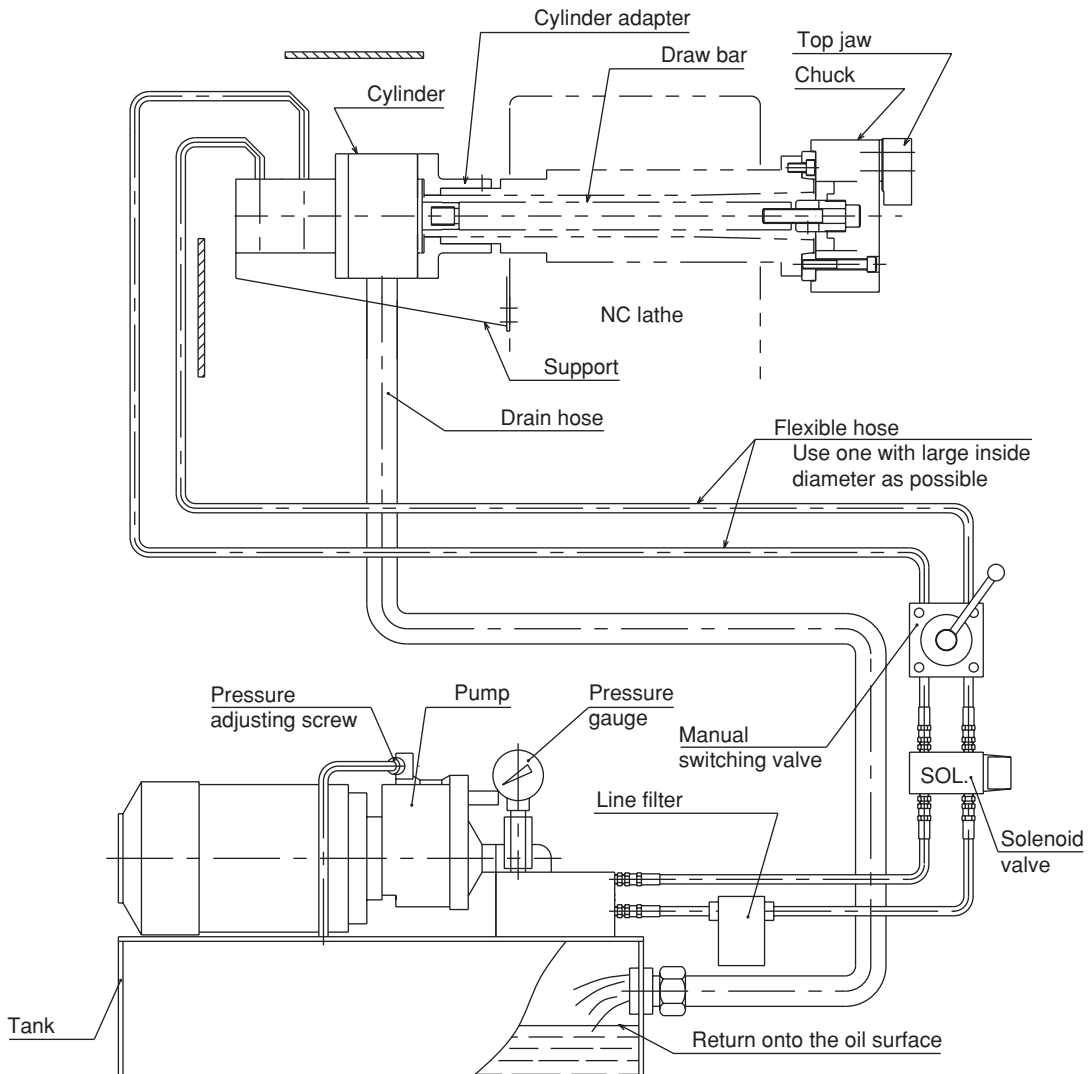

Fig.20

- Attach the manual switching valve at a position where it is easy to operate for the attaching equipment.
- Install the hydraulic unit at a position where the drain hose is not kinked and the needle of the pressure gauge is easily read.

DANGER

- When other actuators are operated by the same hydraulic pressure source as the cylinder for chuck, be sure that a pressure drop of the cylinder does not occur during use. A hydraulic pressure drop leads to a drop in the gripping force which could allow the work to fly out.
- As to the drain hose
 - Use a transparent vinyl hose for visualization.
 - Provide a stream slope, without air pocket. This will ensure no back pressure.
 - The end of the hose is physically above the oil level. (Refer to Fig.20)
- If the hydraulic oil stagnates inside the cylinder, oil leakage occurs, which may cause a fire.

WARNING

- Install after removing the dust inside the pipe completely.
- Add a filter to the pressure supply line. If foreign matters gets inside the cylinder, this is dangerous since the rotation valve of the cylinder will seize, the hose will tear off, and the cylinder will rotate. This is also dangerous as the work will fly out.
- Always use a flexible hose for the hydraulic piping to the cylinder, and the bending force or tensile force of the pipe must not be applied to the cylinder. Use a pipe inside diameter as large as possible and keep the piping length as short as possible.

NOTICE

- Especially, when a large sized hydraulic unit is used, excessive surge pressure is generated and the gripping force becomes large, therefore, it may result in breakage of the chuck or the lowering of endurance. Restrain the surge pressure by adopting a throttle valve, etc.

8-2 In the case that the back plate must be manufactured

1. Production of draw bar

Determine the length of the draw bar as shown below.

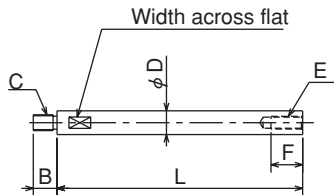

Fig.21

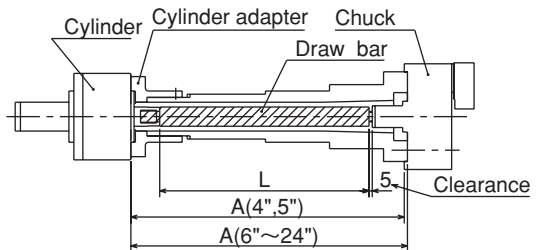

Fig.22

Table 13-1

Type	Hydraulic cylinder	B	C	D (min)	E	F	L
N-04,NT04,NL04	Y0715R	30	M20	30	M10	25	A-54
N-05,NT05	Y0715R	30	M20	30	M12	35	A-45
N-06,NL06,NLT06	Y1020R	30	M20	30	M16	35	A-131.5
N-08,NL08,NLT08	Y1225R	35	M24	35	M20	35	A-162
N-10	Y1225R	35	M24	35	M20	35	A-189
NL10,NLT10	Y1530R	43	M30	45	M20	35	A-194
N-12,NLT12	Y1530R	43	M30	45	M20	35	A-194
NL12	Y1530R	43	M30	45	M24	45	A-78
N-15	Y2035R	55	M36	55	M30	60	A-143
NT15	Y2035R	55	M36	55	M30	60	A-143
N-18	Y2035R	55	M36	55	M30	60	A-131
NL18	Y2050R	55	M36	55	M30	60	A-131
N-21	Y2035R	55	M36	55	M30	60	A-136
N-24	Y2035R	55	M36	55	M30	60	A-136

Table 13-2

Type	Air cylinder	B	C	D (min)	E	F	L
N-04,NT04,NL04	AY1315R	20	M12	20	M10	25	A-43
N-05,NT05	AY1315R	20	M12	20	M12	35	A-34
N-06,NL06,NLT06	AY1720R	25	M16	25	M16	35	A-151.5
N-08,NL08,NLT08	AY2225R	30	M20	30	M20	35	A-182
N-10	AY2225R	30	M20	30	M20	35	A-209

The dimension L in Fig.21 is determined from the distance A between the cylinder adapter and the back plate.

(Example) In the combination of N-06, Y1020RE, and when A=800mm, the draw bar length L is to be

$$L = A - 131.5 = 800 - 131.5 = 668.5\text{mm.}$$

At the time of the screw process of the dimension C, the precision is to be JIS 6H and 6h, 6g matching the screw of the piston of the cylinder. Pay attention so that the thread parts on both ends and the inner periphery do not swing or become unbalanced.

DANGER

- Provide sufficient strength for the draw bar. If the draw bar is broken due to insufficiency of the strength, the gripping force will be lost instantly, which is dangerous as the work will fly out.
- Keep the dimension D in Fig. 21 for the draw bar and a material with the tensile strength 380MPa (38kgf/mm²) or more must be used.
- The personnel who designed draw bar must judge whether the strength of the draw bar is sufficient for the usage conditions.
- The dimensions and materials specified in this manual do not guarantee that the draw bar will not break under every usage condition.
- If the screw-in depth of the draw bar to the draw screw is insufficient, the screw will break and the gripping force will be lost instantly, which is dangerous as the work will fly out.
- If the engagement of the screw of the draw bar is loose, vibration may occur resulting in breakage of the screw. If the screw breaks, the gripping force will be lost instantly, which is dangerous as the work will fly out.
- If the draw bar is unbalanced, vibration occurs, the screw is broken and the gripping force will be lost instantly, which is dangerous as the work will fly out.

2. Production of back plate

NOTICE

- Process the engagement diameter of the back plate after measuring the actual spindle.
- Run-out of the back plate directly affects the process precision. The end surface run-out of the back plate, spigot joint diameter run-out must be 0.005 mm or less.
- The precision of the processing of the chuck attachment end surface of the back plate and the spigot joint diameter can be raised by processing them after mounting to the installed machine.
- Process the chuck attachment spigot joint diameter of the back plate at the target value A-0.01 in the dimension A of Table 14.
- Fig.23 shows the case of the JIS short taper standard.

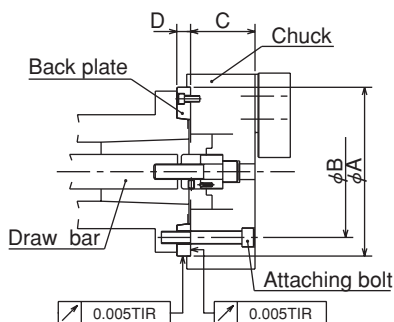

Fig.23

Table14

Type	N-04 NT04 NL04	N-05 NL05	N-06 NL06 NLT06	N-08 NL08 NLT08	N-10 NL10 NLT10	N-12 NL12 NLT12	N-15	N-18	N-21	N-24
φ A (H6)	60	80	140	170	220	220	300	300	380	380
φ B	80	100	104.8	133.4	171.4	171.4	235.0	235.0	235.0	235.0
C	46	48	69	80	84	100	108	108	119	119
D (min)	—	—	15	17	18	18	22	22	27	27

Dimension A (spigot joint diameter) conforms to the DIN standard.

⚠ DANGER

- Always tighten the bolts at the specified torque. If the torque is insufficient or excessive, the bolt will break, which is dangerous as the chuck or work will fly out.
- Use the bolts attached to the chuck, and do not use other bolts. However, if you must use other bolts not provided by Kitagawa, use bolts that have at least a strength classification of 12.9 (10.9 for M22 or more) and be sure they are long enough.

Table 15

Bolt size	Tightening torque	Bolt size	Tightening torque
M 6	13 N·m	M16	250 N·m
M 8	33 N·m	M20	402 N·m
M10	73 N·m	M22	539 N·m
M12	107 N·m	M24	666 N·m
M14	171 N·m		

8-3 In the case of with back plate

Also read “In the case that the back plate must be manufactured” in 8-2 (pages 38-40).

1. Dimensions of power chuck

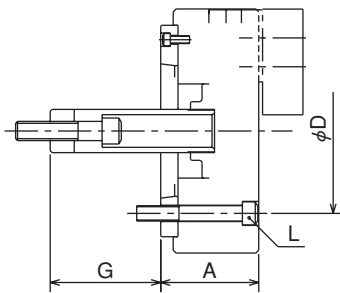

Fig.24

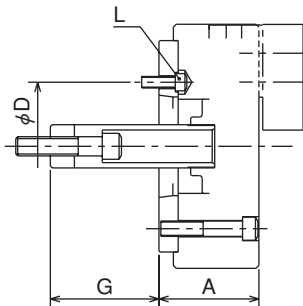

Fig.25

Table 16

Type	A	D	6-L	G		Fig
				MAX.	MIN.	
N-06A05	84	104.8	M10×85	86.5	66.5	24
NL06A05						
NLT06A5						
N-08A06	97	133.4	M12×100	110	89	24
NL08A06						
NLT08A6						
N-10A06	104	133.4	M12×30	114	89	25
NL10A06						
NLT10A6						
N-10A08	102	171.4	M16×110	140	115	24
NL10A08						
NLT10A8						
N-12A06	120	133.4	M12×30	119	89	25
NL12A06						
NLT12A6						
N-12A08	118	171.4	M16×125	145	115	24
NL12A08						
NLT12A8						
N-15A08	130	171.4	M16×45	82	47	25
N-15A11		235.0	M20×140			24
N-18A08	130	171.4	M16×45	70	35	25
N-18A11		235.0	M20×140			24
N-21A08	146	171.4	M16×50	70	35	25
N-21A11		235.0	M20×55			25
N-21A15		330.2	M22×150			24
N-24A11	146	235.0	M20×55	70	35	25
N-24A15		330.2	M22×150			25

2. Production of draw bar

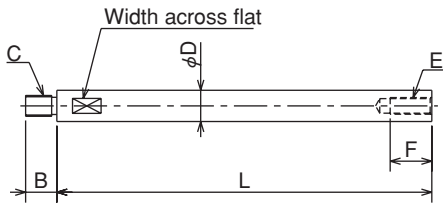

Fig.26

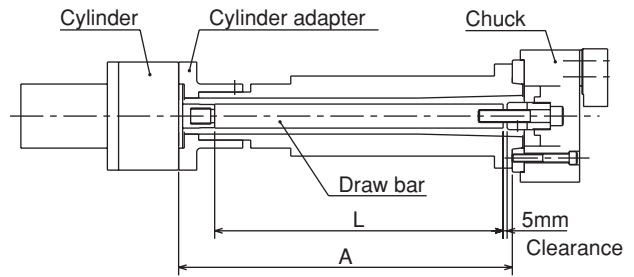

Fig.27

Table 17-1

Type	Hydraulic cylinder	B	C	D (min)	E	F	L
N-06A05 NL06A05 NLT06A5	Y1020R	30	M20	30	M16	35	A-116.5
N-08A05 NL08A05 NLT08A5	Y1225R	35	M24	35	M20	35	A-145
N-10A06 NL10A06 NLT10A6	Y1530R	43	M30	45	M20	35	A-145
N-10A08 NL10A08 NLT10A8	Y1530R	43	M30	45	M20	35	A-171
N-12A06 NLT12A6	Y1530R	43	M30	45	M20	35	A-150

Table 17-2

Type	Hydraulic cylinder	B	C	D (min)	E	F	L
NL12A06	Y1530R	43	M30	45	M24	45	A-58
N-12A08 NLT12A8	Y1530R	43	M30	45	M20	35	A-176
NL12A08	Y1530R	43	M30	45	M24	35	A-60
N-15A08 N-15A11	Y2035R	55	M36	55	M30	60	A-121
N-18A08 N-18A11	Y2035R	55	M36	55	M30	60	A-109
N-21A08 N-21A11 N-21A15	Y2035R	55	M36	55	M30	60	A-109
N-24A11 N-24A15	Y2035R	55	M36	55	M30	60	A-109

The dimension L in Fig.26 is determined from the distance A between the cylinder adapter and the back plate.

(Example) In the combination of N-06A05, Y1020RE, and when A=800mm, the draw bar length

L is to be $L = A - 116.5 = 800 - 116.5 = 683.5\text{mm}$.

At the time of the screw process of the dimension a, the precision is to be JIS 6H and 6h, 6g matching the screw of the piston of the cylinder. Pay attention so that the thread parts on both ends and the inner periphery do not swing or become unbalanced.

8-4 Attachment of chuck

1. Connect the draw tube to plunger

- The draw tube is packed as a separate unit because of packing reason. Install the draw tube to the plunger with a spanner. Then install the lead ball and the set screw., so that it may not be loosened. (Refer to Fig.28)

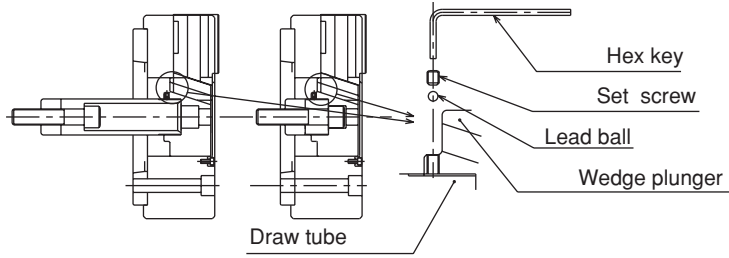

Fig.28

2. Attaching the draw bar to the cylinder

- Apply adhesive onto the screw part of the draw bar, and screw it into the piston rod of cylinder. At this time, refer to the instruction manual for the cylinder for tightening torque.

NOTICE

- When attaching the draw bar to the cylinder, the stopper pin of the piston may break if tightened at the stroke middle position of the piston. In the case of a Y type cylinder, screw it in so that the piston rod is fully in. Follow the explanation of the instruction manual for the cylinder for other items about the cylinder.
- Use the cylinder that matched the stroke of the chuck. The cover is damaged if you use the cylinder that have longer stroke than the chuck, because the jaws move for a long distance.

3. Attach the cylinder to the spindle (or the cylinder adapter)

- Check the run-out of the cylinder, and if it is normal, attach the hydraulic pipe.
- Move 2 to 3 times at low pressure (0.4 MPa-0.5 MPa, 4 - 5 kgf/cm²) and set the piston at the forward end and turn off the power supply.

CAUTION

- Use an eyebolt or a hanging belt when attaching and detaching the chuck to and from the machine, as there is a danger of injury or damage if the chuck drops.

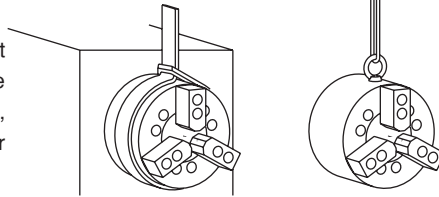

Chuck size(inch)	Eyebolt
4~5"	none
6~10"	M10
12~15"	M12
18~24"	M16

WARNING

- Remove the eyebolt or the belt without fail after using. If the chuck is rotated with the eyebolt, etc., attached, they may fly out and this is dangerous.

4. Connect the chuck to the draw bar

- Remove the soft jaw and the cover of the chuck, and insert the handle or the hex key to the chuck center hole, to connect to the draw bar while turning the draw screw.
- When connecting the draw screw and the draw bar, do not forcibly screw them in if they cannot be screwed smoothly, but check the inclination of the core of the screw, etc.

DANGER

- If the screw-in depth of the draw bar to the draw screw is insufficient, the screw will break and the gripping force will be lost instantly, which will the work to fly out.
- If the engagement of the screw of the draw bar is loose, vibration may occur resulting in breakage of the screw, loss of gripping force and the work flying out.

5. Attach the chuck matching to the attaching surface of the spindle (or the back plate).

- Turn the handle for connection to make a state that the chuck closely contacts the spindle attaching surface of the lathe.
- In the case of adjusting the centering of the chuck, lightly hit the body side face with a plastic hammer.
- Tighten the chuck attaching bolts evenly. At this time, tighten the bolts at the specified torque.

DANGER

- Always tighten the bolts at the specified torque. If the torque is insufficient or excessive, the bolt will break, which is dangerous as the chuck or work will fly out.
- Use the bolts attached to the chuck, and do not use other bolts. However, if you must use other bolts not provided by Kitagawa, use bolts that have at least a strength classification of 12.9 (10.9 for M22 or more) and be sure they are long enough.

Table 18

Bolt size	Tightening torque	Bolt size	Tightening torque
M6	13 N·m	M16	250 N·m
M8	33 N·m	M20	402 N·m
M10	73 N·m	M22	539 N·m
M12	107 N·m	M24	666 N·m
M14	171 N·m		

6. Adjust the position of the wedge plunger

- The appropriate position of the wedge plunger at the cylinder forward end is the position when the dimension A in Fig.29 becomes as shown in the table below.
- At this time, check that the reference mark of the master jaw meets the line of the outside of the stroke mark. (Refer to page 26).
- A click stop (rotation stopper) is also attached to the draw nut, so complete adjustment at the position where this response is felt.

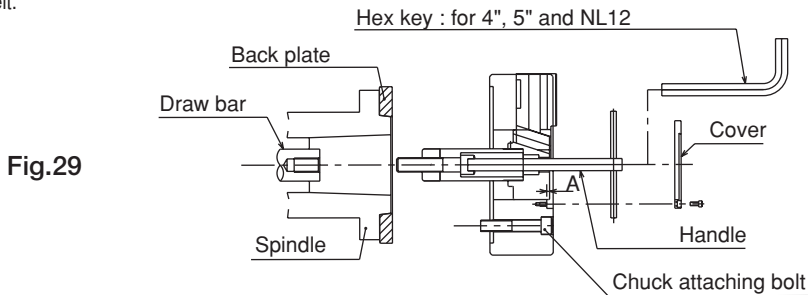

Table 19

Type	A	Type	A
N-04,NT04	0	NL18	-1
N-05,NT05	0	N-21	-1
N-06	0	N-24	-1
N-08	0	NL04	0
N-10	0	—	—
N-12	0	NL06,NLT06	4
N-15	-1	NL08,NLT08	4
NT15	-1	NL10,NLT10	4
N-18	-1	NL12,NLT12	5

7. Attach the cover and check the run-out of the chuck

- Keep the periphery run-out and the end surface run-out of the chuck at 0.02mm T.I.R or less.
- Full stroke the jaw and check that the reference mark of the master jaw is completely within the entire stroke area (Refer to page 26).

9 . Other information

9-1 About standards and orders

This product is based on the following standards or orders.

- Machinery directive : 2006/42/EC Annex I
- EN ISO 12100 : 2010
- EN1550 : 1997+A1 : 2008

9-2 Information about markings of product

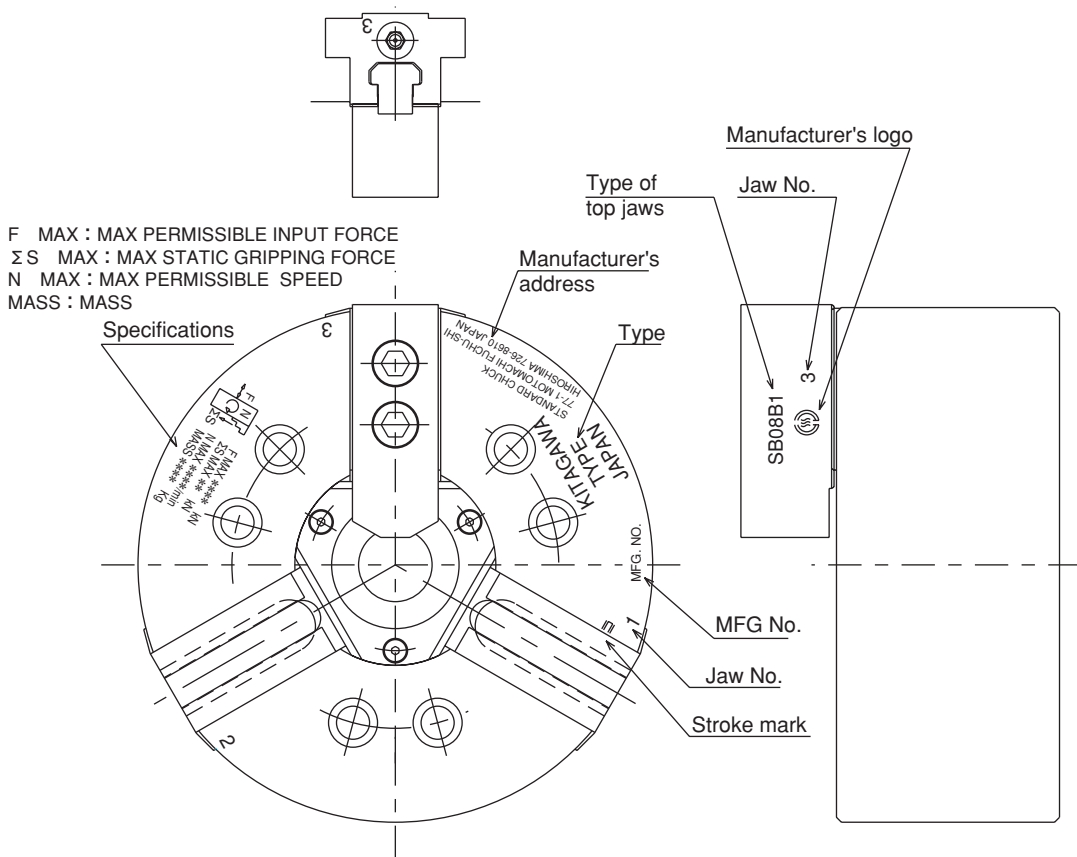

Fig.30

9-3 About disposal

Ultimate disposal of this product should be handled according to all national laws and regulations.

COPY of Original declaration of incorporation

of partly completed machinery

in accordance with the EC Machinery Directive 2006/42/EC Annex II part 1.B

We hereby declare that the following our product conform with the essential health and safety requirements of the EC Machinery Directive so that the product is to be incorporated into end-machinery. The product must not be put into service until end-machinery has been declared in conformity with the provisions of the EC Machinery Directive 2006/42/EC Annex II part 1.A.

We also declare that the specific technical documentation for this partly completed machinery was drawn up according to the EC Machinery Directive 2006/42/EC Annex VII part B. We engage to transmit the specific technical documentation to the market surveillance authorities on their justified request through the person authorized to compile the documentation in our company.

Product : Standard chuck

Model : N / NT / NL / NLT series
(Models N-04, N-05, N-06, N-08, N-10, N-12, N-15, N-18,
N-21, N-24, NT04, NT05, NT15, NL04, NL06,
NL08, NL10, NL12, NL18, NLT06, NLT08,
NLT10, NLT12)

Serial number : See original declaration

Authorized complier
in the community : Mark Jones / Financial Director
UNIT 1 THE HEADLANS, DOWNTON,
SALISBURY, WILTSHIRE, SP5 3JJ, UNITED
KINGDOM

The essential health and safety requirements in accordance with the EC Machinery Directive 2006/42/EC Annex I were applied and fulfilled:
1.1.2, 1.1.3, 1.1.5, 1.1.6, 1.3.1, 1.3.2, 1.3.4, 1.5.4, 1.5.8, 1.5.9, 1.5.13, 1.6.1, 1.7.1,
1.7.2, 1.7.3, 1.7.4, 1.7.4.1, 1.7.4.2

The following harmonized standards were applied:
EN ISO 12100:2010, EN 1550:1997+A1: 2008

Signature : See original declaration

Place / Date : See original declaration

Name / Title : Makoto Otsuka / Manager, Technical section 1
Technical department
Kitagawa Global hand Company

Being the responsible person appointed and employed the manufacturer.

YY3037PKY1

MEMO

Kitagawa Corporation Kitagawa Global hand Company

77-1, Motomachi, Fuchu-shi, Hiroshima, 726-8610, Japan

Tel. +81-847-40-0561

Fax. +81-847-45-8911

■ JAPAN DOMESTIC

Tokyo office	1-405-1, Kita-ku, Yosino-cho, Saitama-shi, Saitama, 331-9634, Japan Tel. +81-48-667-3469 Fax. +81-48-663-4678
Sendai office	4-15-13, Yamatomachi, Wakabayashi-ku, Sendai-shi, Miyagi, 984-0042, Japan Tel. +81-22-232-6732 Fax. +81-22-232-6739
Nagoya office	2-62, Kamitakabata, Nakagawa-ku, Nagoya-shi, Aichi, 454-0873, Japan Tel. +81-52-363-0371 Fax. +81-52-362-0690
Osaka office	3-2-9, Kitagagaya, Suminoe-ku, Osaka-shi, Osaka, 559-0011, Japan Tel. +81-6-6685-9065 Fax. +81-6-6684-2025
Hiroshima office	77-1, Motomachi, Fuchu-shi, Hiroshima, 726-8610, Japan Tel. +81-847-40-0541 Fax. +81-847-46-1721
Kyushu office	7-6-39, Itazuke, Hakata-ku, Fukuoka-shi, Fukuoka, 812-0888, Japan Tel. +81-92-501-2102 Fax. +81-92-501-2103
Overseas office	77-1, Motomachi, Fuchu-shi, Hiroshima, 726-8610, Japan Tel. +81-847-40-0526 Fax. +81-847-45-8911

■ OVERSEAS

America Contact	KITAGAWA-NORTHTECH INC. 301 E. Commerce Dr, Schaumburg, IL. 60173 USA Tel. +1 847-310-8787 Fax. +1 847-310-9484 http://www.kitagawa.us
	TECNARA TOOLING SYSTEMS, INC. 12535 McCann Dr, Santa Fe Springs, CA. 90670 USA Tel. +1 562-941-2000 Fax. +1 562-946-0506 http://www.tecnaratools.com
Europe Contact	KITAGAWA EUROPE LTD. Unit 1 The Headlands, Downton, Salisbury, Wiltshire SP5 3JJ, United Kingdom Tel. +44 1725-514000 Fax. +44 1725-514001 http://www.kitagawa.global/en
	KITAGAWA EUROPE GmbH Borsigstrasse 3, 40880, Ratingen Germany Tel. +49 2102-123-78-00 Fax. +49 2102-123-78-69 http://www.kitagawa.global/de
	KITAGAWA EUROPE GmbH Poland Office 44-240 Zory, ul. Niepodleglosci 3 Poland Tel. +48 607-39-8855 http://www.kitagawa.global/pl
	KITAGAWA EUROPE GmbH Czech Office Purkynova 125, 612 00 Brno, Czech Republic Tel. +420 603-856-122 Fax. +420 549-273-246 http://www.kitagawa.global/cz
	KITAGAWA EUROPE GmbH Romania Office Strada Heliului 15, Bucharest 1, 013991, Romania Tel. +40 727-770-329 http://www.kitagawa.global/ro
	KITAGAWA EUROPE GmbH Hungary Office Dery T. u. 5, H-9024 Gyor, Hungary Tel. +36 30-510-3550 http://www.kitagawa.global/hu
Asia Contact	KITAGAWA INDIA PVT LTD. Plot No.215, 4th Phase, Bommasandra Industrial Area, Bommasandra Jigani Link Road, Bangalore 560 099, Karnataka, India Tel. +91-80-2976-5200 Fax. +91-80-2976-5205 http://www.kitagawa.global/in
	KITAGAWA (THAILAND) CO., LTD. Bangkok Branch 9th FL, Home Place Office Building, 283/43 Sukhumvit 55Rd. (Thonglor 13), Klongton-Nua, Wattana, Bangkok 10110, Thailand Tel. +66 2-712-7479 Fax. +66 2-712-7481
	Kitagawa Corporation (Shanghai) Room 308 3F Building B. Far East International Plaza, No.317 Xian Xia Road, Chang Ning, Shanghai, 200051, China Tel. +86 21-6295-5772 Fax. +86 21-6295-5792 http://www.kiw-sh.com
	Kitagawa Corporation (Shanghai) Guangzhou Office B07, 25/F, West Tower, Yangcheng International Trading Centre, No.122, East Tiyu Road, Tianhe District, Guangzhou, China Tel. +86 20-2885-5276
	DEAMARK LIMITED No. 6, Lane 5, Lin Sen North Road, Taipei, Taiwan Tel. +886 2-2393-1221 Fax. +886 2-2395-1231 http://www.deamark.com.tw
KITAGAWA KOREA AGENT CO., LTD. 803 Ho, B-Dong, Woolim Lion's Valley, 371-28 Gasan-Dong, Gumcheon-Gu, Seoul, Korea Tel. +82 2-2026-2222 Fax. +82 2-2026-2113 http://www.kitagawa.co.kr	
Oceania Contact	DIMAC TOOLING PTY. LTD. 69-71 Williams Rd, Dandenong South, Victoria, 3175 Australia Tel. +61 3-9561-6155 Fax. +61 3-9561-6705 http://www.dimac.com.au

The products herein are controlled under Japanese Foreign Exchange and Foreign Trade Control Act. In the event of importing and/or exporting the products, you are obliged to consult KITAGAWA as well as your government for the related regulation prior to any transaction.